



# LFM200S SERIES 200 WATT AC-DC POWER SUPPLY WITH PFC

## Features

- Universal Input Range 85~264Vac
- High Efficiency up to 94%
- Class I
- 25.4mm Low Profile Package
- No Load Input Power Consumption<0.3W
- 48V, 54V No Load Input Power Consumption<0.4W
- Approval IEC/EN/UL 62368-1 Ed 3.0
- Approval EN55032 and CISPR/FCC Class B
- Meets IEC/EN 60335-1
- Operating Altitude 5000m
- Continuous Short Circuit Protection
- Over Voltage Protection
- Over Temperature Protection
- High Power Density 28.35W/Inches<sup>3</sup>
- Active PFC Function
- Over Voltage Category OVC II & OVC III



MODEL NUMBER	OUTPUT VOLTAGE	OUTPUT CURRENT			RIPPLE & NOISE NOTE1	VOLTAGE ACCURACY NOTE2	LINE REGULATION NOTE3	LOAD REGULATION NOTE4	%EFF. (Typ) NOTE5
		With Fan NOTE6	Without Conduction Cooling	With Conduction Cooling NOTE7					
LFM200S120C	12 V	16.67 A	9.17 A	14.17 A	150 mV	±1%	±0.2%	±0.5%	92%
LFM200S150C	15 V	13.33 A	7.33 A	11.33 A	150 mV	±1%	±0.2%	±0.5%	92%
LFM200S240C	24 V	8.33 A	4.58 A	7.08 A	200 mV	±1%	±0.2%	±0.5%	94%
LFM200S280C	28 V	7.14 A	3.93 A	6.07 A	200 mV	±1%	±0.2%	±0.5%	93%
LFM200S300C	30 V	6.66 A	3.67 A	5.67 A	200 mV	±1%	±0.2%	±0.5%	93%
LFM200S360C	36 V	5.55 A	3.06 A	4.72 A	200 mV	±1%	±0.2%	±0.5%	94%
LFM200S480C	48 V	4.16 A	2.29 A	3.54 A	200 mV	±1%	±0.2%	±0.5%	94%
LFM200S540C	54 V	3.7 A	2.04 A	3.15 A	200 mV	±1%	±0.2%	±0.5%	93%

Note:

1. Add a 0.1uF ceramic capacitor and a 10uF E.L. capacitor to output for ripple & noise measuring @20MHz BW.
2. Voltage accuracy is set at full load.
3. Line regulation is measured from 100Vac to 240Vac with full load.
4. Load regulation is measured from 10% to 100% full load.
5. Typical efficiency at 230 Vac and full load at 25°C.
6. Forced air convection with 14CFM above 110Vac.
7. With addition cooling conduction plate, 17.78 by 17.78 cm with min. 0.2 cm thick, as below.



# LFM200S Series

## PART NUMBER

Series	Number of Outputs	Nominal Output Voltage	Type	Mounting Inserts
LFM200	O	XXX	X	-YZ
LFM200	S : Single	120 : 12V 150 : 15V 240 : 24V 280 : 28V 300 : 30V 360 : 36V 480 : 48V 540 : 54V	C : With Cover	Blank : Through Hole C0 : Threaded Hole

Part Number Example:

**LFM200S120C-C0**: With Cover 200W, Single 12Vdc Output, Threaded Hole



# LFM200S Series

## TECHNICAL SPECIFICATIONS

(All specifications are typical at nominal input, full load at 25°C unless otherwise noted.)

### ABSOLUTE MAXIMUM RATINGS

PARAMETER	NOTES and CONDITIONS	Device	Min.	Typ.	Max.	Units
Input Voltage	Safety approvals only to the AC input	All	85		264	V <sub>ac</sub>
Input Voltage		All	115		370	V <sub>dc</sub>
Operating Temperature	See Derating Curve	All	-40		80	°C
Operating Case Temperature	At the center of base plate (T <sub>c</sub> = Case temperature)	All	-40		90	°C
Storage Temperature		All	-40		85	°C
Operating Altitude	IEC/EN/UL 62368-1 OVC II IEC/EN/UL 62368-1 OVC III	All			5000 2000	m

### INPUT CHARACTERISTICS

PARAMETER	NOTES and CONDITIONS	Device	Min.	Typ.	Max.	Units
Operating Voltage Range		All	100		240	V <sub>ac</sub>
Input Frequency Range		All	47		63	Hz
Maximum Input Current	100% Load, V <sub>in</sub> =100V <sub>ac</sub>	All			3.15	A
Leakage Current	Contact leakage current Earth leakage current	All			100 300	uA
Inrush Current	V <sub>in</sub> =240V <sub>ac</sub> , Cold Start @25°C	All			85	A
Power Factor	230V <sub>ac</sub> @ Full load	All	0.96	0.98		

### OUTPUT CHARACTERISTICS

PARAMETER	NOTES and CONDITIONS	Device	Min.	Typ.	Max.	Units
Output Voltage Set Point	V <sub>in</sub> =Nominal V <sub>in</sub> , I <sub>o</sub> =I <sub>o</sub> max., T <sub>c</sub> =25°C	LFM200S120C	11.88	12	12.12	V <sub>dc</sub>
		LFM200S150C	14.85	15	15.15	
		LFM200S240C	23.76	24	24.24	
		LFM200S280C	27.72	28	28.28	
		LFM200S300C	29.7	30	30.3	
		LFM200S360C	35.64	36	36.36	
		LFM200S480C	47.52	48	48.48	
Operating Output Current Range	V <sub>in</sub> =85V <sub>ac</sub> ~264V <sub>ac</sub> , See Derating Curve	LFM200S120C	0		16.67	A
		LFM200S150C	0		13.33	
		LFM200S240C	0		8.33	
		LFM200S280C	0		7.14	
		LFM200S300C	0		6.66	
		LFM200S360C	0		5.55	
		LFM200S480C	0		4.16	
LFM200S540C	0		3.7			
Holdup Time	V <sub>in</sub> =115V <sub>ac</sub>	All	10	12		ms
Output Voltage Regulation						
Load Regulation	10% Load to full load	All			±0.5	%
Line Regulation	V <sub>in</sub> =High line to low line	All			±0.2	%
Output Voltage Adjustment	P <sub>o</sub> ≤ max. rated power, I <sub>o</sub> ≤ I <sub>o</sub> max.	All	-5		+5	%



# LFM200S Series

PARAMETER	NOTES and CONDITIONS	Device	Min.	Typ.	Max.	Units
Over Voltage Protection	Latch off (AC recycle to reset)	LFM200S120C			16	V <sub>dc</sub>
		LFM200S150C			20	
		LFM200S240C			32	
		LFM200S280C			35	
		LFM200S300C			35	
		LFM200S360C			45	
		LFM200S480C			55	
		LFM200S540C			63	
Over Current Protection	Auto recovery (output is rated load)	All	125	145	165	%
Short Circuit Protection	Auto recovery	All				
Over Temperature Protection	Auto recovery	All				
Output Ripple and Noise	1. Add a 0.1uF ceramic capacitor and a 10uF aluminum electrolytic capacitor to output 2. Oscilloscope is 20MHz band width. 3. Ambient Temperature=25°C	LFM200S120C			150	mV
		LFM200S150C			150	
		LFM200S240C			200	
		LFM200S280C			200	
		LFM200S300C			200	
		LFM200S360C			200	
		LFM200S480C			200	
		LFM200S540C			200	
Load Capacitance	1. V <sub>in</sub> =115V <sub>ac</sub> and 230V <sub>ac</sub> 2. Output is max. load 3. Ambient temperature=25°C	LFM200S120C			6800	uF
		LFM200S150C			5360	
		LFM200S240C			3440	
		LFM200S280C			3440	
		LFM200S300C			3220	
		LFM200S360C			2680	
		LFM200S480C			2000	
		LFM200S540C			1560	
Efficiency	1. Input Voltage is 230Vac 2. Output is rated load 3. Ambient temperature=25°C	LFM200S120C		92		%
		LFM200S150C		92		
		LFM200S240C		94		
		LFM200S280C		93		
		LFM200S300C		93		
		LFM200S360C		94		
		LFM200S480C		94		
		LFM200S540C		93		

## ISOLATION CHARACTERISTICS

PARAMETER	NOTES and CONDITIONS	Device	Min.	Typ.	Max.	Units
Input to Output	1 Minute (without dielectric breakdown)	All			4250	V <sub>ac</sub>
Input to Earth (Ground)	1 Minute (without dielectric breakdown)	All			2000	V <sub>ac</sub>
Output to Earth (Ground)	1 Minute (without dielectric breakdown)	All			2000	V <sub>ac</sub>
Isolation Resistance	Input to output	All	100			MΩ

## FEATURE CHARACTERISTICS

PARAMETER	NOTES and CONDITIONS	Device	Min.	Typ.	Max.	Units
Switching Frequency		15V		130		kHz
		Others		110		



# LFM200S Series

## GENERAL SPECIFICATIONS

PARAMETER	NOTES and CONDITIONS	Device	Min.	Typ.	Max.	Units
MTBF	I <sub>o</sub> =100%; T <sub>a</sub> =25°C per MIL-HDBK-217F	All	450			k hours
Life Time	@75% Load, 40°C	All	26			k hours
Humidity	Non-condensing	All			93	% RH
Shock	Meet MIL-STD-810F Table 516.5, Table 516.5-1 10ms, each axis 3 times(±X、±Y、±Z axis)	All		75		g
Vibration	Meet MIL-STD-810F Table 514.5C-VIII, 15~2000Hz, X、Y、Z axis, 1 hour (each axis),. Total 3 hrs.	All		4		g
Weight		All		220		grams
Dimensions			3.09x2.28x1.00 Inches (78.6x57.9x25.4 mm)			
<b>Safety</b>	Class I, IEC/EN/UL 62368-1					Ed. 3.0
<b>EMC Emission</b>	EN 55032:2015+A11:2020, EN 61000-6-4:2019, EN 61204-3:2018, EN 61000-3-2:2019+A1:2021, EN 61000-3-3:2013+A2:2021, 47 CFR FCC Part 15					
Conducted Disturbance	EN 55032, 47 CFR FCC Part 15					Class B
Radiated Disturbance	EN 55032, 47 CFR FCC Part 15					Class B
Harmonic Current Emissions	EN 61000-3-2:2019+A1:2021					Class A, C, D
Voltage Fluctuations & Flicker	EN 61000-3-3:2013+A2:2021					Criterion A
<b>EMC Immunity</b>	EN 55035:2017+A11:2020, EN 61000-6-2:2019, EN 61204-3:2018					
Electrostatic Discharge (ESD)	IEC 61000-4-2:2008 Air Discharge: ±8kV, Contact Discharge: ±4kV					Criterion A
Radio-Frequency, Continuous Radiated Disturbance	IEC 61000-4-3:2020					Criterion A
Electrical Fast Transient (EFT)	IEC 61000-4-4:2012, ±2kV					Criterion A
Surge	IEC 61000-4-5:2014+A1:2017, L-N: ±2kV, L-E (Ground): ±4kV					Criterion A
Conducted Disturbances, Induced by RF Fields	IEC 61000-4-6:2013+COR1:2015					Criterion A
Power Frequency Magnetic Field	IEC 61000-4-8:2009					Criterion A
Voltage Dips	IEC 61000-4-11:2020, Dip: 30% 10ms, Dip: 60% 100ms, Dip >95% 5000ms					Criterion A
Voltage Interruptions	IEC 61000-4-11:2020, >95% 5000ms					Criterion B
Application Note Link						<a href="#">LFM200S Series App Notes</a>



## CHARACTERISTIC CURVE

### Power Derating Curve

Output Power vs Ambient Temperature

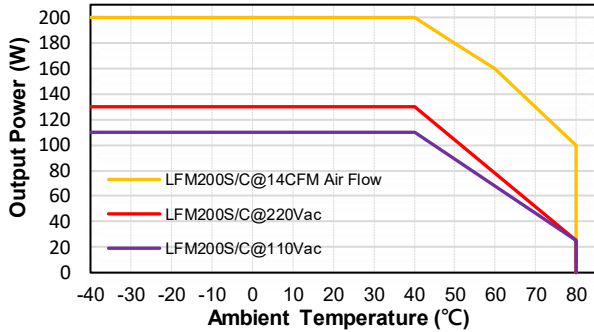

Output Power & Input Voltage

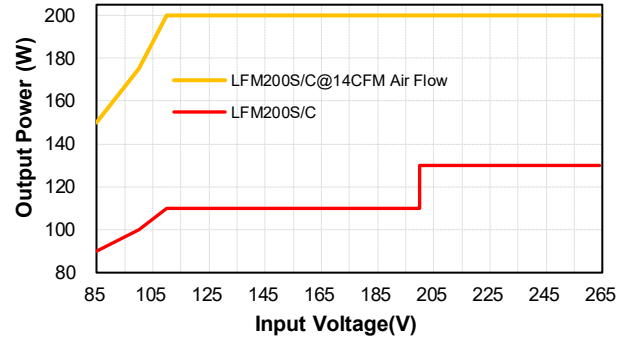

### Conduction Convection with External Baseplate (17.78cmx17.78cmx0.2cm)

Output Power vs Ambient Temperature

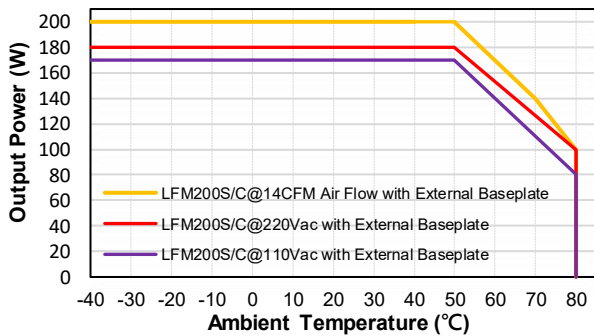

Output Power & Input Voltage

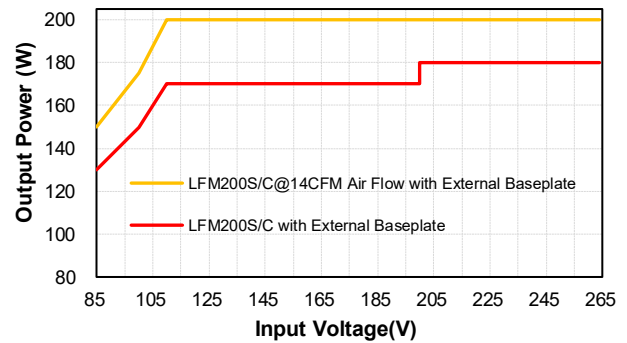

Output Power vs Case Temperature (Tc)

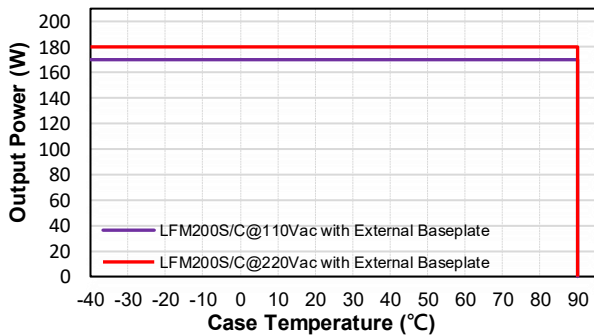



# LFM200S Series

## Performance Data

LFM200S120 (Eff Vs Io)

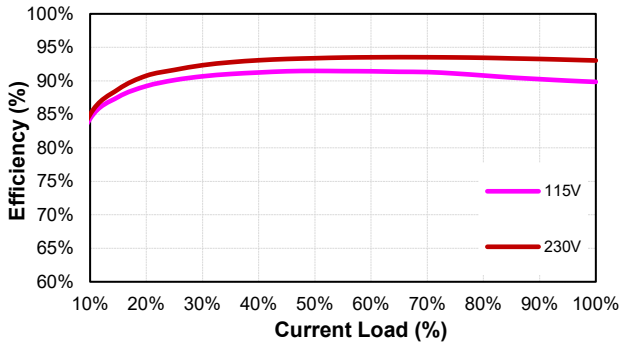

LFM200S150 (Eff Vs Io)

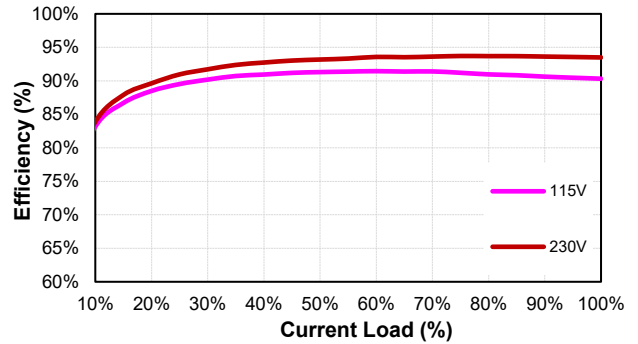

LFM200S240 (Eff Vs Io)

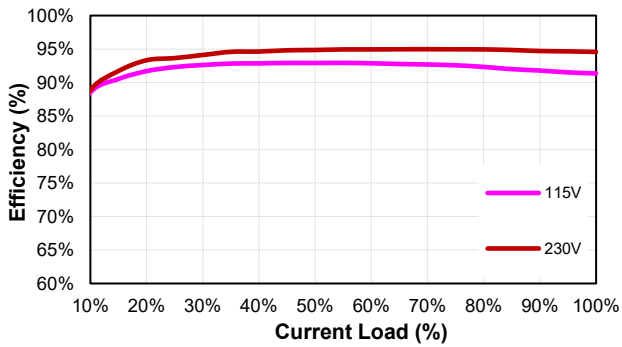

LFM200S280 (Eff Vs Io)

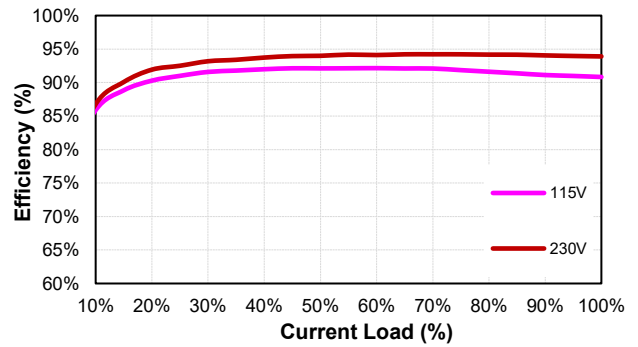

LFM200S300 (Eff Vs Io)

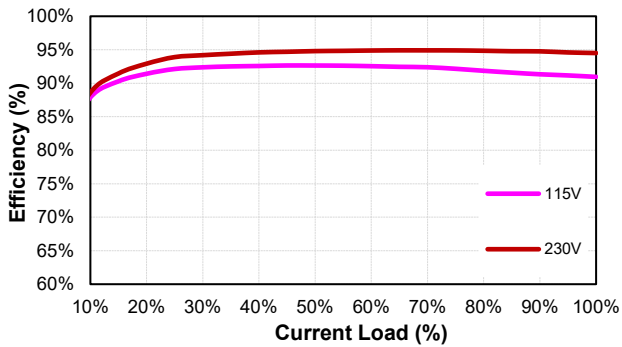

LFM200S360 (Eff Vs Io)

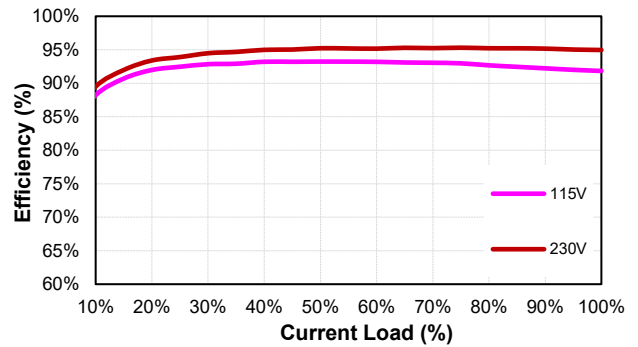

LFM200S480 (Eff Vs Io)

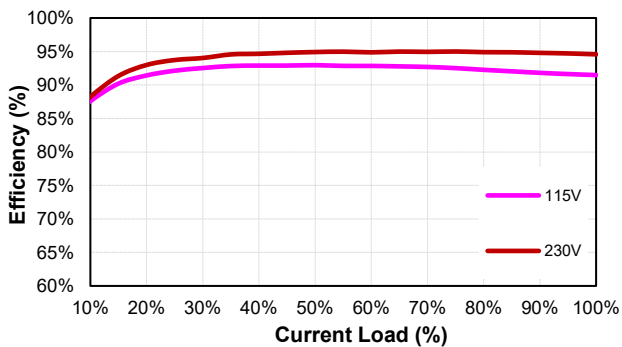

LFM200S540 (Eff Vs Io)

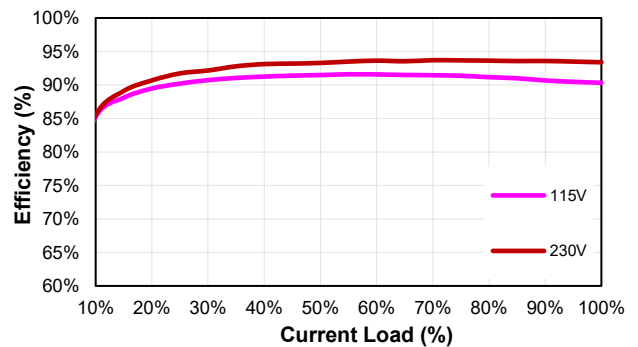



# LFM200S Series

## MECHANICAL SPECIFICATION

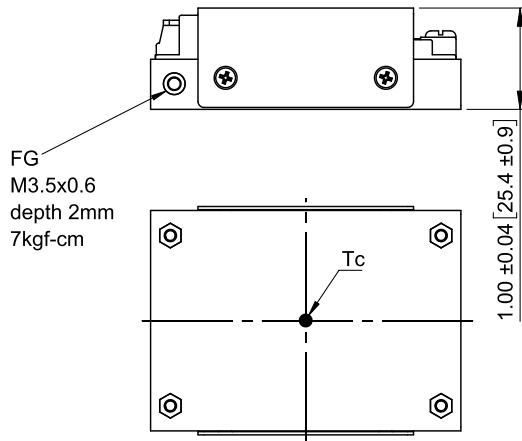
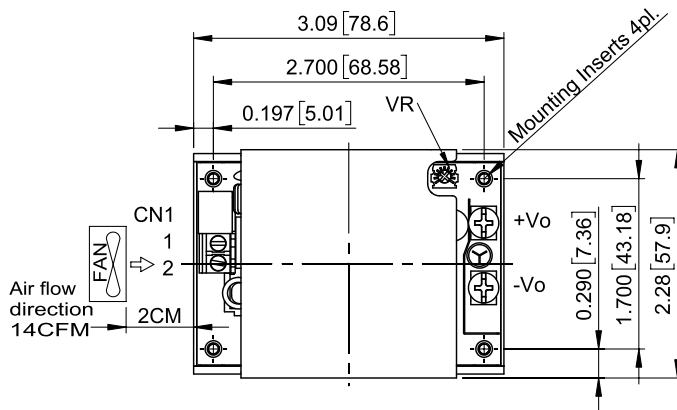

### LFM200SXXXC LFM200SXXXC-C0

All Dimensions in Inches[mm]

Tolerance Inches: x.xx=±0.03, x.xxx=±0.020

Millimeters: x.x=±0.7, x.xx=±0.50

AC Input Connector(CN1):ECE ETB22

Pin	Function	Mating Wire Range
1	ACL	14~18 AWG
2	ACN	

DC Output Connector:KANG YANG PCB-58M4

Function	The screws locked torque
+Vo	M4 7kgf-cm
-Vo	

Mounting Inserts

Series	Option
Blank	∅3.2 Through depth 10.5mm
-C0	M3x0.5 Threaded depth 10.5mm

CINCON Electronics Co. Ltd.  
 Add: 14F, No. 306, Sec.4, Hsin Yi Rd., Taipei, Taiwan  
 Tel: 886-2-27086210  
 Fax: 886-2-27029852  
 E-mail: [sales@cincon.com](mailto:sales@cincon.com)  
 Web: [www.cincon.com](http://www.cincon.com)