



# EC2SB 10W Isolated DC-DC Converters

Application Note V12 November 2020

## ISOLATED DC-DC Converter EC2SB SERIES APPLICATION NOTE



Approved By:

Department	Approved By	Checked By	Written By
Research and Development Department	Enoch	Tim	Joyce
		Jacky	
Quality Assurance Department	Ryan	Benny	



# EC2SB 10W Isolated DC-DC Converters

Application Note V12 November 2020

---

## Content

<b>1. INTRODUCTION</b>	<b>3</b>
<b>2. DC-DC CONVERTER FEATURES</b>	<b>3</b>
<b>3. ELECTRICAL BLOCK DIAGRAM</b>	<b>3</b>
<b>4. TECHNICAL SPECIFICATIONS</b>	<b>5</b>
<b>5. MAIN FEATURES AND FUNCTIONS</b>	<b>10</b>
5.1 Operating Temperature Range	10
5.2 Over Current Protection	10
5.3 Remote On/Off	10
<b>6. APPLICATIONS</b>	<b>10</b>
6.1 Recommended Layout PCB Footprints and Soldering Information	10
6.2 Power De-Rating Curves for EC2SB Series	11
6.3 Efficiency vs. Load Curves	12
6.4 Input Capacitance at the Power Module	17
6.5 Test Set-Up	17
6.6 Output Voltage Adjustment	17
6.7 Output Ripple and Noise Measurement	18
6.8 Output Capacitance	18
<b>7. SAFETY &amp; EMC</b>	<b>19</b>
7.1 Input Fusing and Safety Considerations.	19
7.2 EMC Considerations	19
<b>8. PART NUMBER</b>	<b>25</b>
<b>9. MECHANICAL SPECIFICATIONS</b>	<b>25</b>



# EC2SB 10W Isolated DC-DC Converters

## Application Note V12 November 2020

### 1. Introduction

The EC2SB series offer 10 watts of output power in a 1.00x1.00x0.4 inches Copper packages. The EC2SB series has a 2:1 wide input voltage range of 4.7-9, 9-18, 18-36 and 36-75VDC and provides a precisely regulated output. This series has features such as high efficiency, 1500VDC of isolation and allows an ambient operating temperature range of  $-40^{\circ}\text{C}$  to  $85^{\circ}\text{C}$  (de-rating above  $71^{\circ}\text{C}$ ). The features include short circuit protection and remote on/off control. All models are very suitable for distributed power architectures, telecommunications, battery operated equipment and industrial applications.

### 2. DC-DC Converter Features

- 10W Isolated Output
- Efficiency to 87%
- 2:1 Input Range
- Regulated Outputs
- Fixed Switching Frequency
- Input under-voltage Protection
- Over Current Protection
- Remote On/Off
- Continuous Short Circuit Protection
- Conductive EMI Meets EN55032 Class A
- Without Tantalum Capacitors Inside
- Safety Meets IEC/EN/UL 62368-1

### 3. Electrical Block Diagram

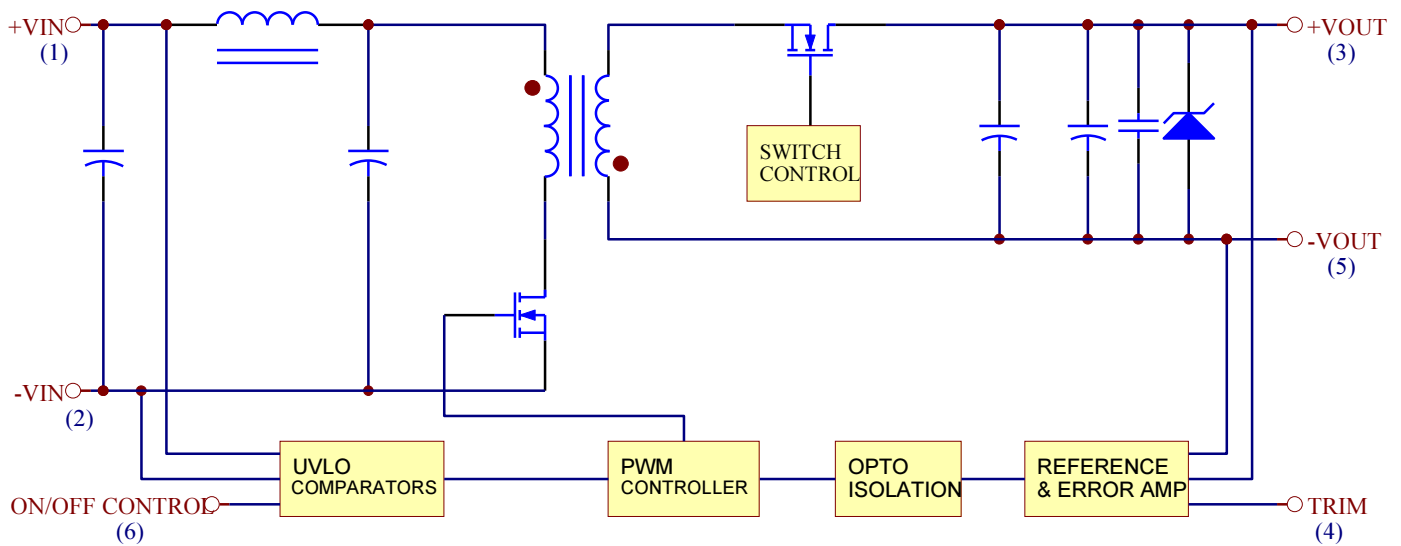

Figure 1 Electrical Block Diagram for Single Output Modules



# EC2SB 10W Isolated DC-DC Converters

## Application Note V12 November 2020

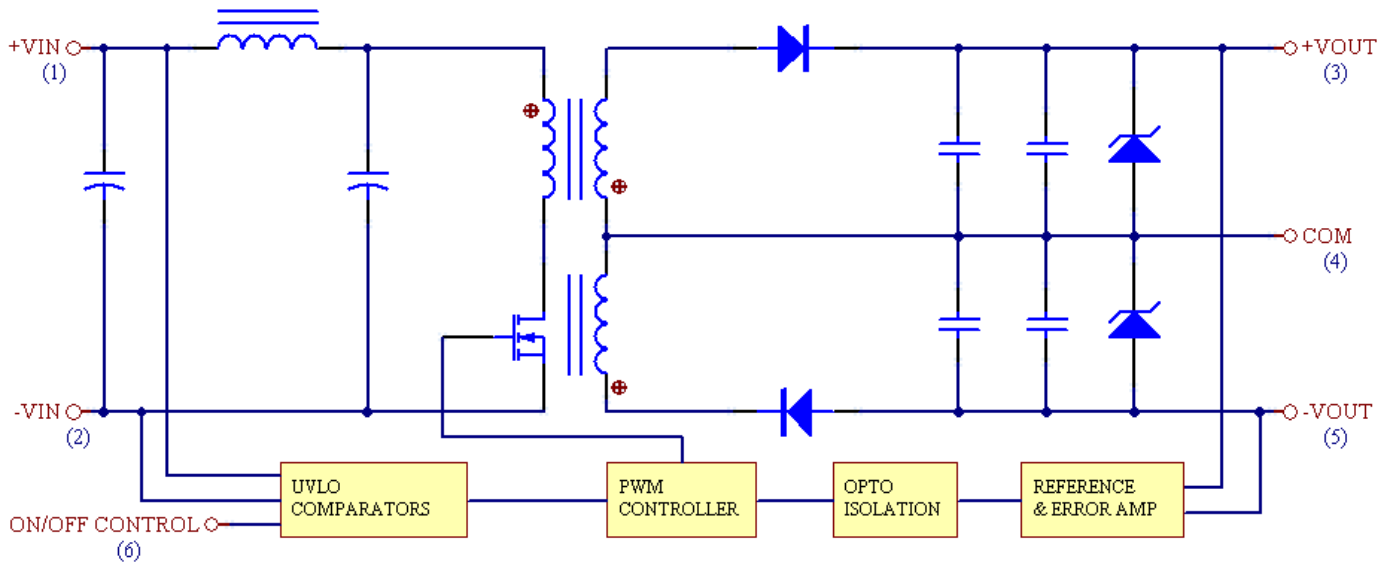

Figure 2 Electrical Block Diagram for Dual Output Modules



# EC2SB 10W Isolated DC-DC Converters

## Application Note V12 November 2020

### 4. Technical Specifications

(All specifications are typical at nominal input, full load at 25°C unless otherwise noted.)

#### **ABSOLUTE MAXIMUM RATINGS**

PARAMETER	NOTES and CONDITIONS	Device	Min.	Typical	Max.	Units
Input Voltage						
Continuous		05SXX	-0.3		9	Vdc
		12SXX	-0.3		18	
		24SXX	-0.3		36	
		48SXX	-0.3		75	
Transient	100ms	05SXX			12	Vdc
		12SXX			25	
		24SXX			50	
		48SXX			100	
Operating Ambient Temperature	De-rating, Above 71°C	All	-40		+85	°C
Case Temperature		All			105	°C
Storage Temperature		All	-55		+125	°C
Input/Output Isolation Voltage	1 minute	All	1500			Vdc

#### **INPUT CHARACTERISTICS**

PARAMETER	NOTES and CONDITIONS	Device	Min.	Typical	Max.	Units
Operating Input Voltage		05SXX	4.7	5	9	Vdc
		12SXX	9	12	18	
		24SXX	18	24	36	
		48SXX	36	48	75	
Turn-On Voltage Threshold		05SXX	4.2	4.4	4.6	Vdc
		12SXX	8.4	8.8	9.2	
		24SXX	16.5	17	17.5	
		48SXX	33.5	34	34.5	
Turn-Off Voltage Threshold		05SXX	4	4.2	4.4	Vdc
		12SXX	7.7	8	8.3	
		24SXX	15.5	16	16.7	
		48SXX	31.5	32	32.5	
Lockout Hysteresis Voltage		05SXX		0.3		Vdc
		12SXX		0.5		
		24SXX		1		
		48SXX		1		
Maximum Input Current	100% Load, Vin=4.7V for 05XXX	05SXX			2700	mA
	100% Load, Vin=9V for 12XXX	12SXX			1350	
	100% Load, Vin=18V for 24XXX	24SXX			675	
	100% Load, Vin=36V for 48XXX	48SXX			338	



# EC2SB 10W Isolated DC-DC Converters

## Application Note V12 November 2020

PARAMETER	NOTES and CONDITIONS	Device	Min.	Typical	Max.	Units
No-Load Input Current	Vin=Nominal input	05S33		120		mA
		05S05		120		
		05S12		50		
		05S15		50		
		05D05		50		
		05D12		50		
		05D15		50		
		12S33		30		
		12S05		30		
		12S12		30		
		12S15		35		
		12D05		45		
		12D12		45		
		12D15		45		
		24S33		25		
		24S05		25		
		24S12		25		
		24S15		25		
		24D05		25		
		24D12		25		
24D15		25				
48S33		20				
48S05		20				
48S12		20				
48S15		20				
48D05		20				
48D12		20				
48D15		20				
Inrush Current (I <sup>2</sup> t)		All			0.1	A <sup>2</sup> s
Input Reflected-Ripple Current	P-P thru 12uH inductor, 5Hz to 20MHz	All			30	mA

### OUTPUT CHARACTERISTIC

PARAMETER	NOTES and CONDITIONS	Device	Min.	Typical	Max.	Units
Output Voltage Set Point	Vin=Nominal Vin , Io=Io.max, Tc=25°C	Vo=3.3V	3.2505	3.3	3.3495	Vdc
		Vo=5.0V	4.925	5.0	5.075	
		Vo=12V	11.82	12	12.18	
		Vo=15V	14.77	15	15.225	
		Vo=±5V	4.925	5.0	5.075	
		Vo=±12V	11.82	12	12.18	
		Vo=±15V	14.77	15	15.225	



# EC2SB 10W Isolated DC-DC Converters

## Application Note V12 November 2020

PARAMETER	NOTES and CONDITIONS	Device	Min.	Typical	Max.	Units
Output Voltage Regulation						
Load Regulation	Io=Io.min to Io.max	DIP Single			±0.2	%
		SMD Single			±0.5	
		Dual			±1.0	
Line Regulation	Vin=low line to high line	DIP Single			±0.2	%
		SMD Single			±0.3	
		Dual			±0.5	
Temperature Coefficient	Tc=-40°C to 85°C	All			±0.03	%/°C
Output Voltage Ripple and Noise						
20MHz bandwidth						
Peak-to-Peak	Full Load	DIP			50	mV
		SMD			100	
Operating Output Current Range		Vo=3.3V			2.5	A
		Vo=5.0V			2	
		Vo=12V			0.833	
		Vo=15V			0.666	
		Vo=±5V			±1	
		Vo=±12V			±0.416	
Vo=±15V			±0.333			
Output DC Current-Limit Inception	Output Voltage =90% VOnominal	All	110	130	140	%
Maximum Output Capacitance	Full load, Resistance	Vo=3.3V			2470	uF
		Vo=5.0V			2000	
		Vo=12V			940	
		Vo=15V			690	
		Vo=±5V			1000	
		Vo=±12V			440	
Vo=±15V			330			

### DYNAMIC CHARACTERISTICS

PARAMETER	NOTES and CONDITIONS	Device	Min.	Typical	Max.	Units
Output Voltage Current Transient						
0.1A/us						
Step Change in Output Current	50% to 75% and 75% to 100% of Io.max	All			±4	%
Setting Time (within 1% VOnominal)	di/dt=0.1A/us	All			500	us
Turn-On Delay and Rise Time						
Turn-On Delay Time, From On/Off Control	Von/off to 10%Vo, set	All		10		ms
Turn-On Delay Time, From Input	Vin,min. to 10%Vo,set	All		10		ms
Output Voltage Rise Time	10%Vo, set to 90%Vo, set	All		5		ms



# EC2SB 10W Isolated DC-DC Converters

## Application Note V12 November 2020

### EFFICIENCY

PARAMETER	NOTES and CONDITIONS	Device	Min.	Typical	Max.	Units
100% Load		05S33		87		%
		05S05		87		
		05S12		87		
		05S15		87		
		05D05		85		
		05D12		87		
		05D15		87		
		12S33		82		
		12S05		85		
		12S12		87		
		12S15		87		
		12D05		85		
		12D12		87		
		12D15		87		
		24S33		82		
		24S05		85		
		24S12		87		
		24S15		87		
		24D05		85		
		24D12		87		
		24D15		87		
		48S33		81		
		48S05		85		
		48S12		87		
48S15		87				
48D05		85				
48D12		87				
48D15		87				

### ISOLATION CHARACTERISTICS

PARAMETER	NOTES and CONDITIONS	Device	Min.	Typical	Max.	Units
Input to Output	1 minutes	All	1500			Vdc
Isolation Resistance		All			1000	MΩ
Isolation Capacitance		All		1000		pF

### FEATURE CHARACTERISTICS

PARAMETER	NOTES and CONDITIONS	Device	Min.	Typical	Max.	Units
Switching Frequency		All		350		KHz





# EC2SB 10W Isolated DC-DC Converters

## Application Note V12 November 2020

PARAMETER	NOTES and CONDITIONS	Device	Min.	Typical	Max.	Units
On/Off Control, Positive Remote On/Off logic						
Logic Low (Module Off)	Von/off at Ion/off=1.0mA	All	0		1.2	V
Logic High (Module On)	Von/off at Ion/off=0.1uA	All	5.5 or open circuit		75	V
On/Off Control, Negative Remote On/Off logic						
Logic High (Module On)	Von/off at Ion/off=1.0mA	All		N/A		V
Logic Low (Module Off)	Von/off at Ion/off=0.0uA	All		N/A		V
On/Off Current (for both remote on/off logic)	Ion/off at Von/off=0.0V	All			1	mA
Leakage Current (for both remote on/off logic)	Logic High, Von/off=15V	All			30	uA
Off Converter Input Current	Shutdown input idle current	5Vin 24Vin 48Vin		5	10	mA
		12Vin		10	15	
Output Voltage Trim Range	Pout=max rated power	All	-10		+10	%
Output Over Voltage Protection		Vo=3.3V		3.9		V
		Vo=5.0V		6.2		
		Vo=12V		15		
		Vo=15V		18		
		Vo±5V		±6.2		
		Vo±12V		±15		
Over-Temperature Shutdown		All		N/A		°C

### GENERAL SPECIFICATIONS

PARAMETER	NOTES and CONDITIONS	Device	Min.	Typical	Max.	Units
MTBF	Io=100% of Io_max; Ta=25°C per MIL-HDBK-217E Notice 1 GB	All		1.2		M hours
Weight		All		18		grams



# EC2SB 10W Isolated DC-DC Converters

## Application Note V12 November 2020

### 5. Main Features and Functions

#### 5.1 Operating Temperature Range

The EC2SB series converters can be operated by a wide ambient temperature range from  $-40^{\circ}\text{C}$  to  $85^{\circ}\text{C}$  (de-rating above  $71^{\circ}\text{C}$ ) The standard model has a Copper case and case temperature can not over  $105^{\circ}\text{C}$  at normal operating.

#### 5.2 Over Current Protection

All different voltage models have full continuous short-circuit protection. To provide protection in a fault condition, the unit is equipped with internal over-current protection. The unit operates normally once the fault condition is removed. At the point of current-limit inception, the converter will go into over current protection.

#### 5.3 Remote On/Off

The EC2SB series allows the user to switch the module on and off electronically with the remote on/off feature. All models are available in “positive logic” versions. The converter turns on if the remote on/off pin is high ( $>5.5\text{Vdc}$  to  $75\text{Vdc}$  or open circuit). Setting the pin low ( $0$  to  $<1.2\text{Vdc}$ ) will turn the converter off. The signal level of the remote on/off input is defined with respect to ground. If not using the remote on/off pin, leave the pin open (converter will be on).

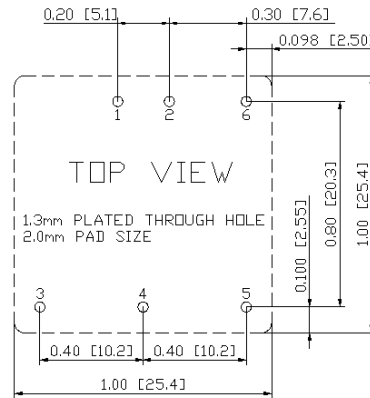

Note: Dimensions are in inches (millimeters)

Lead Free Wave Soldering Profile

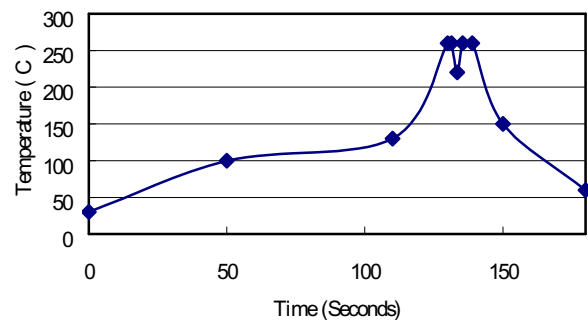

Note :

1. Soldering Materials: Sn/Cu/Ni
2. Ramp up rate during preheat:  $1.4^{\circ}\text{C}/\text{Sec}$  (From  $50^{\circ}\text{C}$  to  $100^{\circ}\text{C}$ )
3. Soaking temperature:  $0.5^{\circ}\text{C}/\text{Sec}$  (From  $100^{\circ}\text{C}$  to  $130^{\circ}\text{C}$ ),  $60 \pm 20$  seconds
4. Peak temperature:  $260^{\circ}\text{C}$ , above  $250^{\circ}\text{C}$  3~6 Seconds
5. Ramp up rate during cooling:  $-10.0^{\circ}\text{C}/\text{Sec}$  (From  $260^{\circ}\text{C}$  to  $150^{\circ}\text{C}$ )

Figure3 Recommended PCB Layout Footprints and Wave Soldering Profiles for SB packages

### 6. Applications

#### 6.1 Recommended Layout PCB Footprints and Soldering Information

The system designer or the end user must ensure that other components and metal in the vicinity of the converter meet the spacing requirements to which the system is approved. Low resistance and low inductance PCB layout traces are the norm and should be used where possible. Due consideration must also be given to proper low impedance tracks between power module, input and output grounds. The recommended footprints and soldering profiles are shown as Figure 3.



# EC2SB 10W Isolated DC-DC Converters

## Application Note V12 November 2020

### 6.2 Power De-Rating Curves for EC2SB Series

Operating Ambient temperature Range:  $-40^{\circ}\text{C} \sim 71^{\circ}\text{C}$  without de-rating.

Maximum case temperature under any operating condition should not exceed  $105^{\circ}\text{C}$ .

Typical Derating curve for Natural Convection

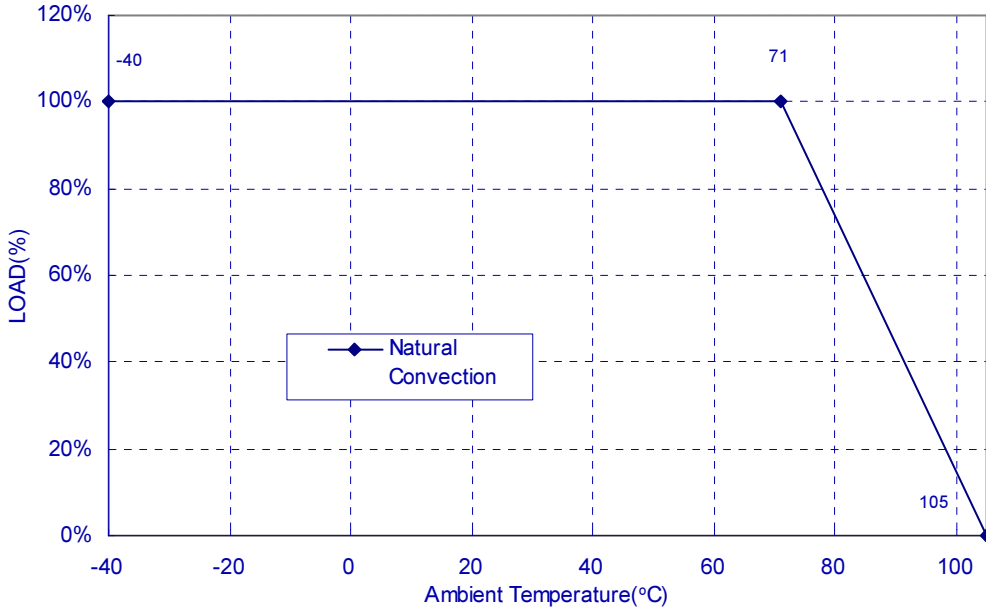



# EC2SB 10W Isolated DC-DC Converters

## Application Note V12 November 2020

### 6.3 Efficiency vs. Load Curves

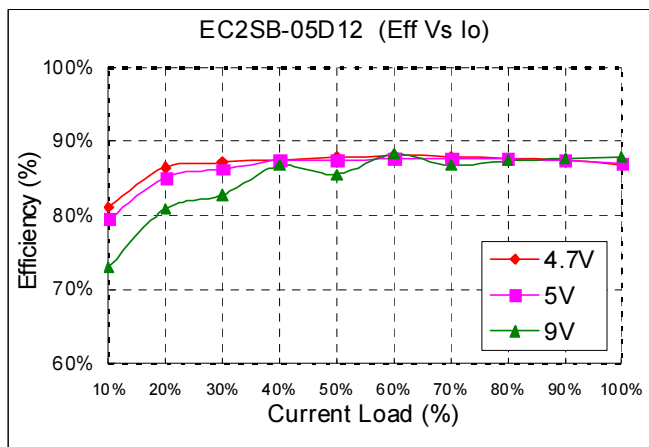
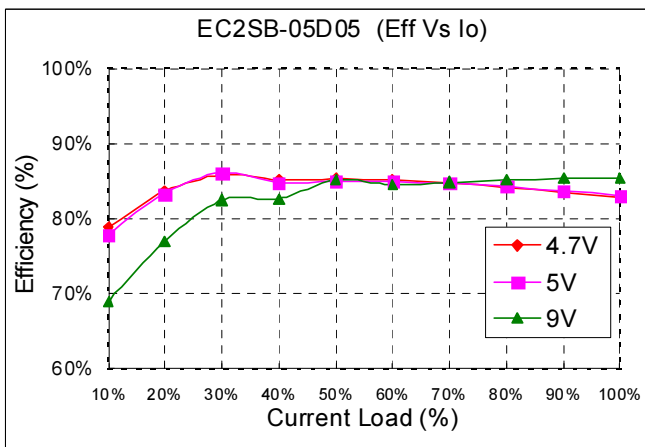
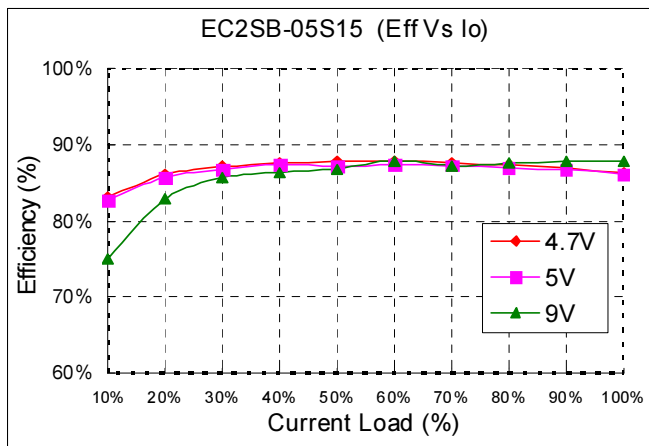
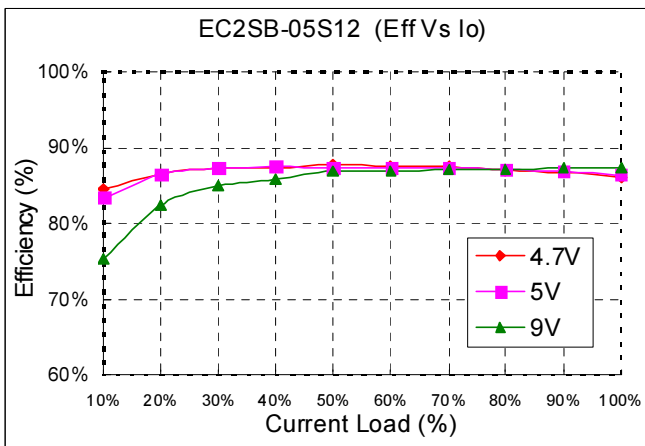
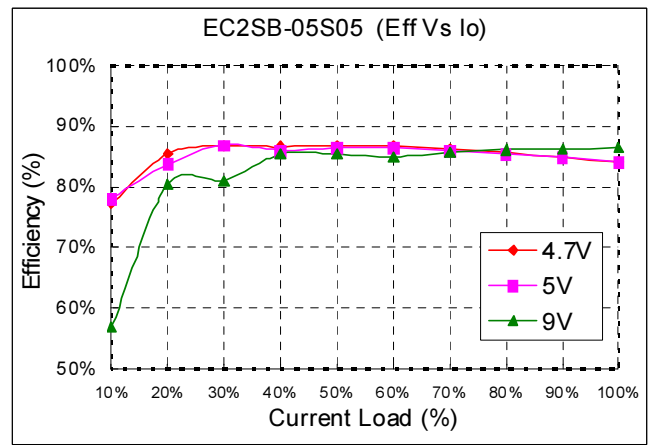
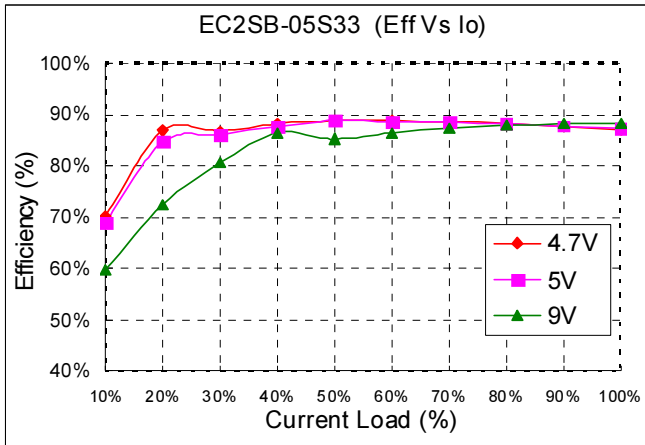



# EC2SB 10W Isolated DC-DC Converters

## Application Note V12 November 2020

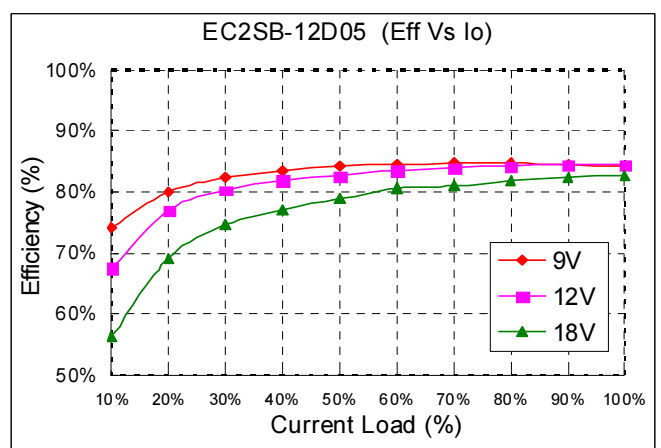
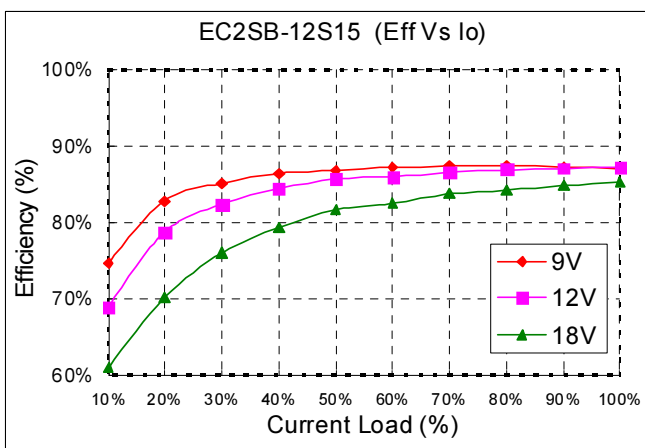
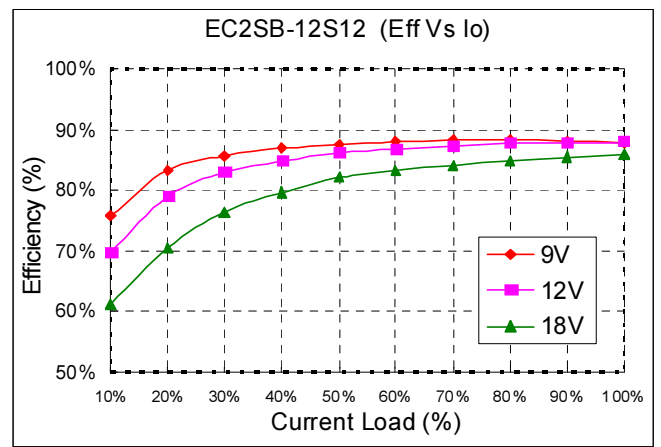
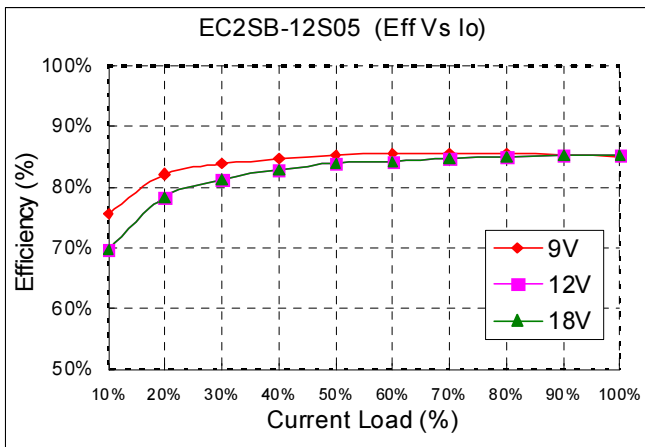
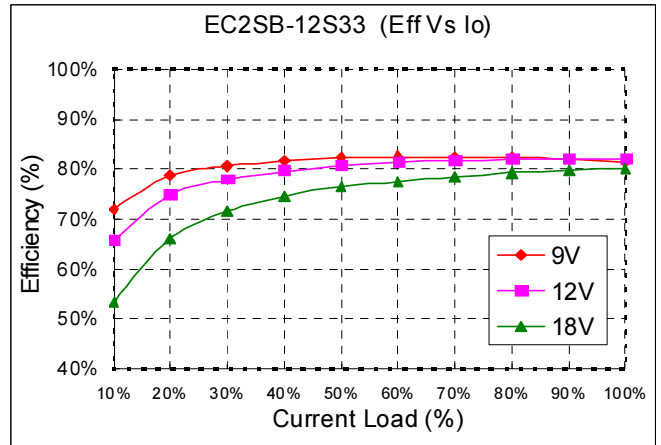
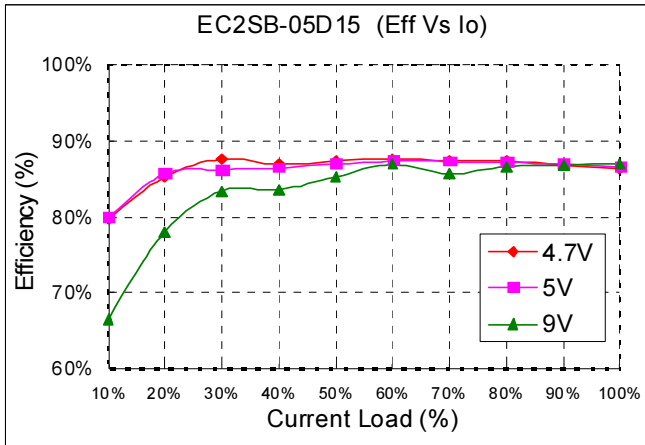



# EC2SB 10W Isolated DC-DC Converters

## Application Note V12 November 2020

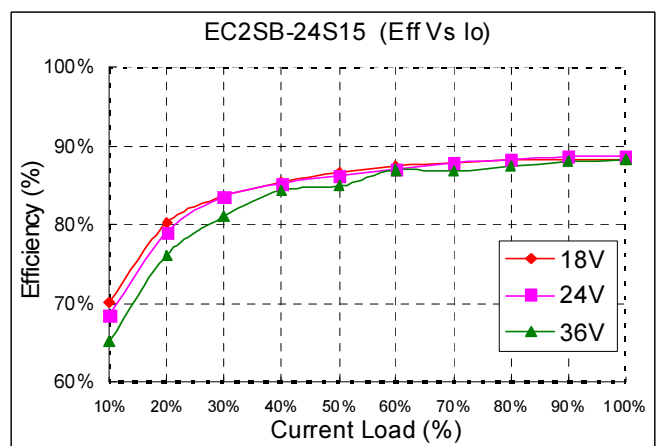
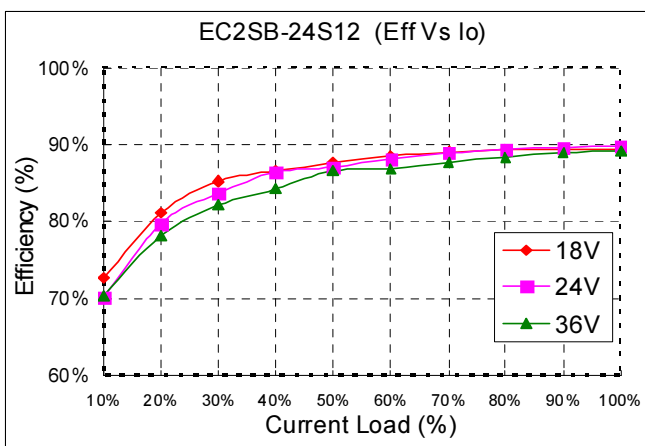
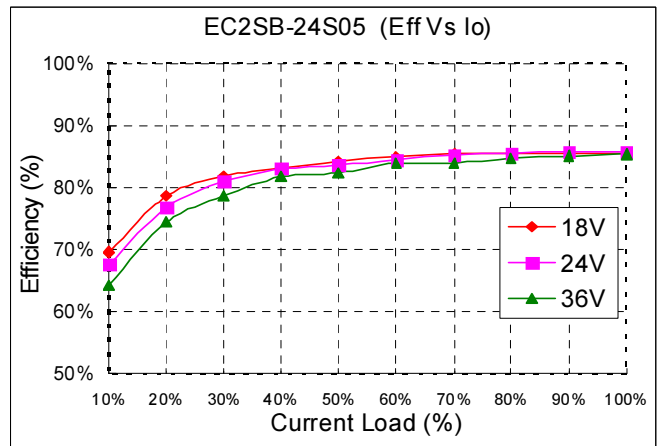
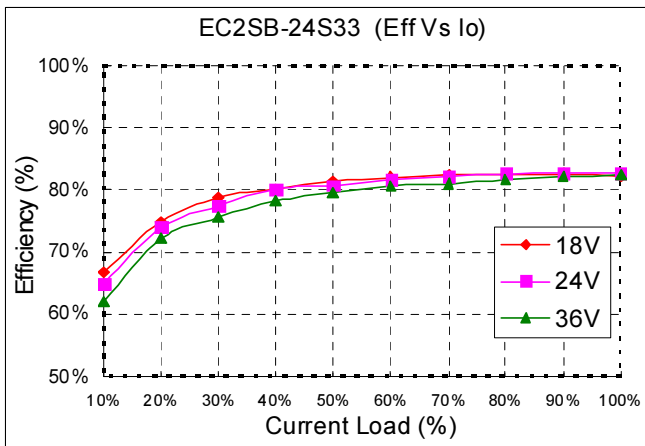
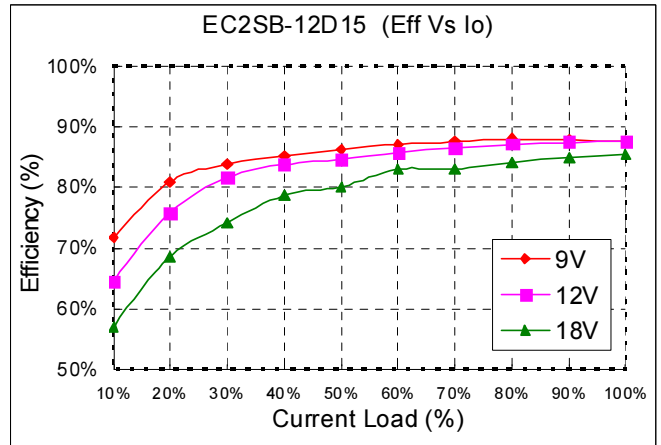
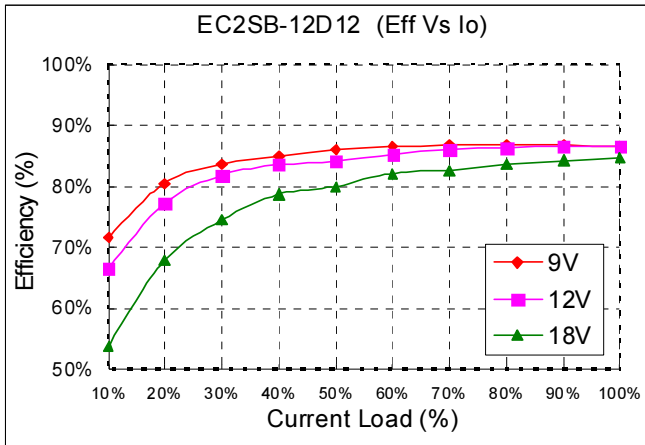



# EC2SB 10W Isolated DC-DC Converters

## Application Note V12 November 2020

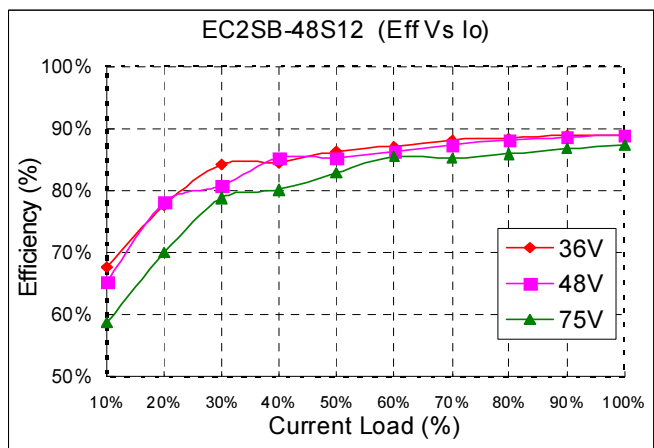
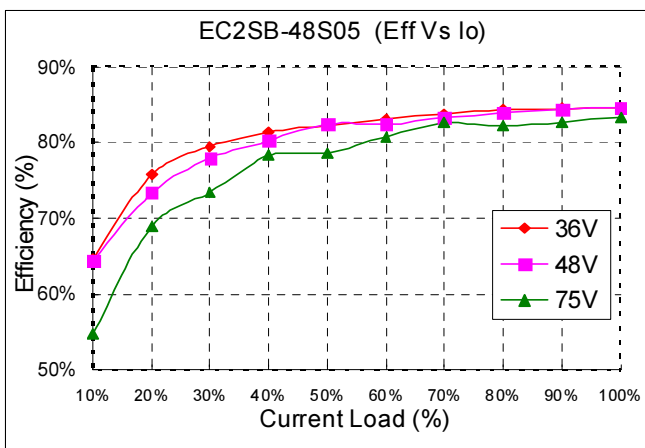
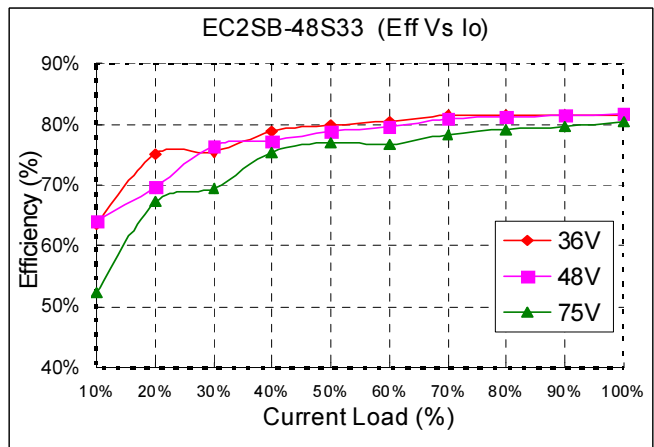
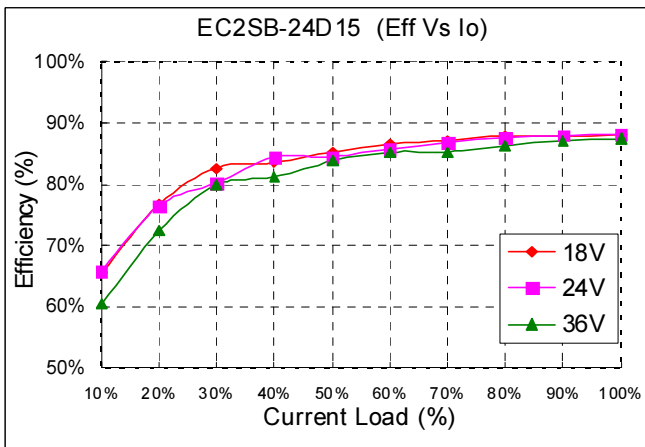
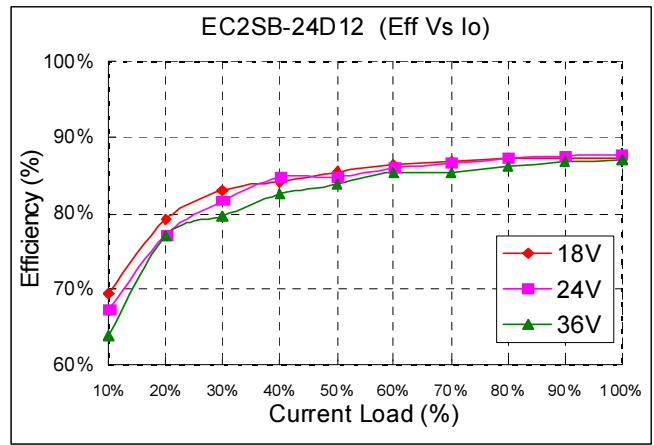
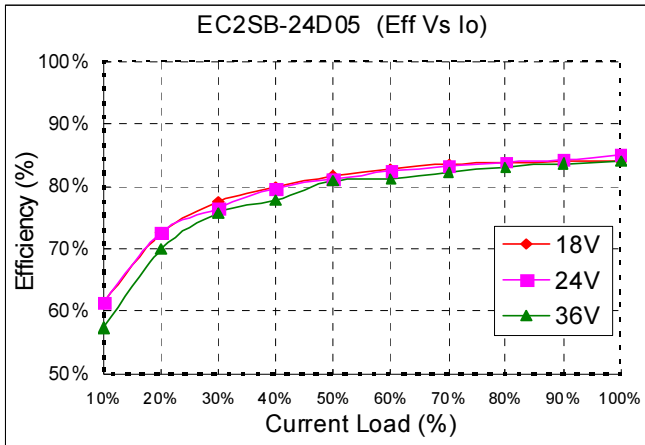



# EC2SB 10W Isolated DC-DC Converters

## Application Note V12 November 2020

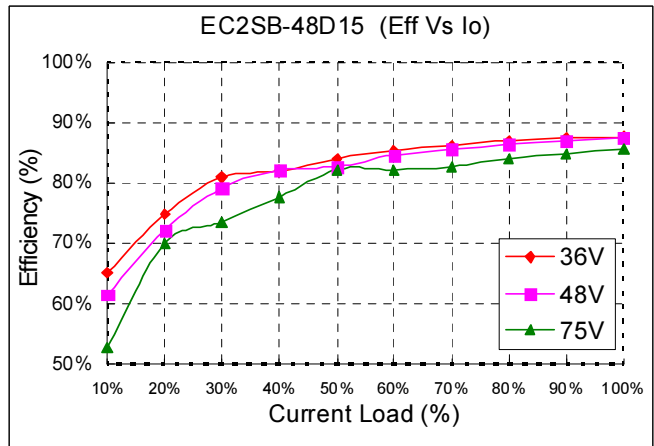
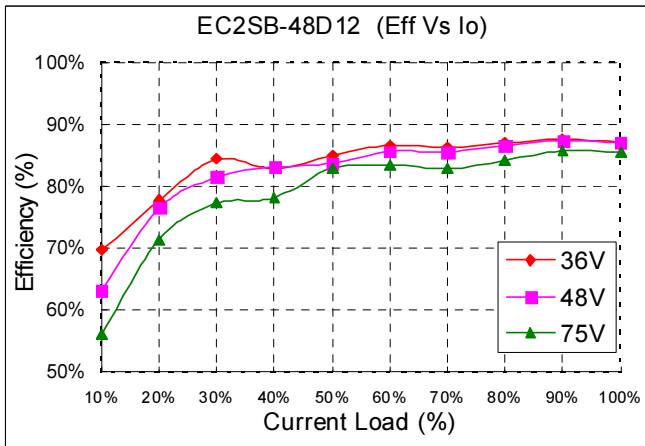
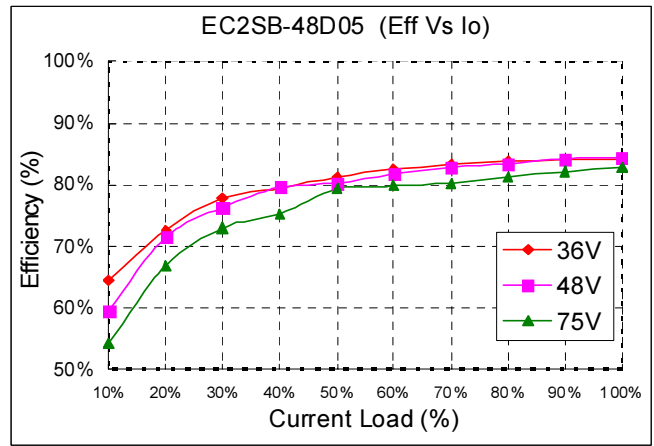
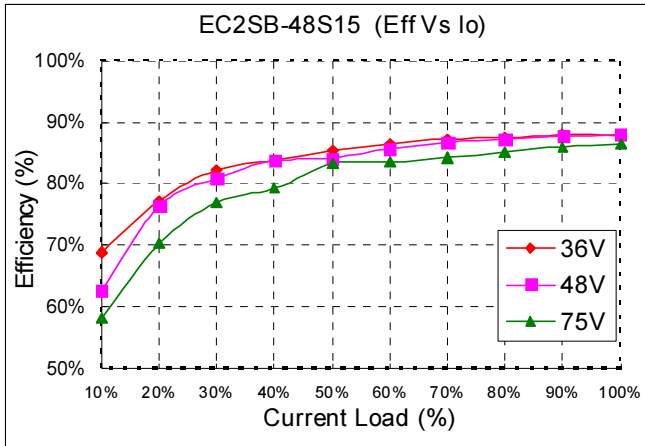





# EC2SB 10W Isolated DC-DC Converters

## Application Note V12 November 2020

### 6.4 Input Capacitance at the Power Module

The converters must be connected to low AC source impedance. To avoid problems with loop stability source inductance should be low. Also, the input capacitors (Cin) should be placed close to the converter input pins to de-couple distribution inductance. However, the external input capacitors are chosen for suitable ripple handling capability. Low ESR capacitors are good choice. Circuit as shown in Figure 4 represents typical measurement methods for reflected ripple current. C1 and L1 simulate a typical DC source impedance. The input reflected-ripple current is measured by current probe to oscilloscope with a simulated source Inductance (L1).

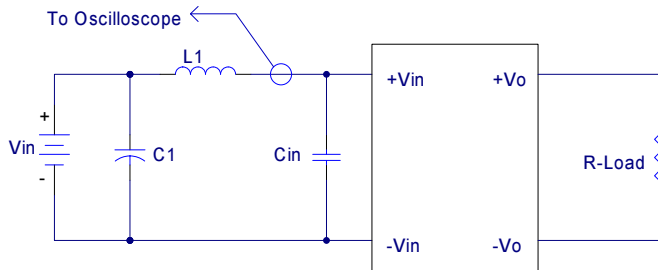

L1: 10uH  
 C1: None  
 Cin: 22uF ESR<0.66ohm @100KHz  
 Figure4 Input Reflected-Ripple Test Setup

### 6.5 Test Set-Up

The basic test set-up to measure parameters such as efficiency and load regulation is shown in Figure 5. When testing the modules under any transient conditions please ensure that the transient response of the source is sufficient to power the equipment under test. We can calculate the

- Efficiency
- Load regulation and line regulation.

The value of efficiency is defined as:

$$\eta = \frac{V_o \times I_o}{V_{in} \times I_{in}} \times 100\%$$

Where

- Vo is output voltage
- Io is output current
- Vin is input voltage
- Iin is input current

The value of load regulation is defined as:

$$Load.reg = \frac{V_{FL} - V_{NL}}{V_{NL}} \times 100\%$$

Where

- V<sub>FL</sub> is the output voltage at full load
- V<sub>NL</sub> is the output voltage at 10% load

The value of line regulation is defined as:

$$Line.reg = \frac{V_{HL} - V_{LL}}{V_{LL}} \times 100\%$$

Where:

V<sub>HL</sub> is the output voltage of maximum input voltage at full load.

V<sub>LL</sub> is the output voltage of minimum input voltage at full load.

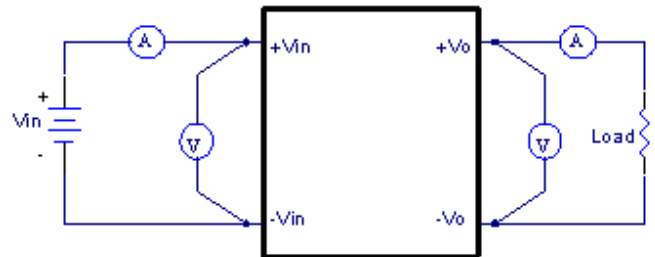

Figure5 EC2SB Series Test Setup

### 6.6 Output Voltage Adjustment

In order to trim the voltage up or down one needs to connect the trim resistor either between the trim pin and -Vo for trim-up and between trim pin and +Vo for trim-down. The output voltage trim range is ±10%. This is shown in Figures 1 and 2:

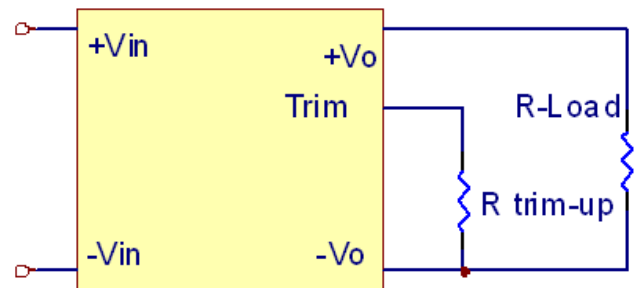

Figure1. Trim-up Voltage Setup

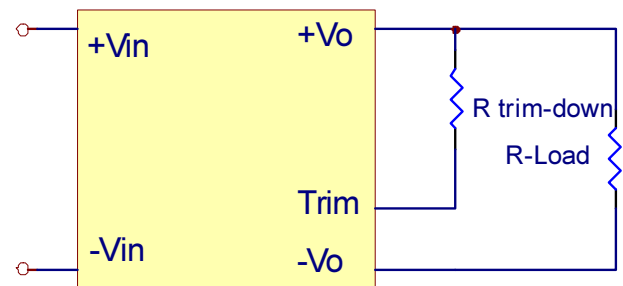

Figure2. Trim-down Voltage Setup

1. The value of R<sub>trim-up</sub> defined as:

$$R_{trim-up} = \left( \frac{V_r \times R1 \times (R2 + R3)}{(V_o - V_{o,nom}) \times R2} \right) - R_t \text{ (K}\Omega\text{)}$$



# EC2SB 10W Isolated DC-DC Converters

## Application Note V12 November 2020

Where:

R trim-up is the external resistor in Kohm.

Vo,nom is the nominal output voltage.

Vo is the desired output voltage.

R1, Rt, R2, R3 and Vr are internal to the unit and are

Defined in Table 1.

Model Number	Output Voltage(V)	R1 (Kohm)	R2 (Kohm)	R3 (Kohm)	Rt (Kohm)	Vr
EC2SB-05S33 EC2SB-12S33 EC2SB-24S33 EC2SB-48S33	3.3	2.70	1.8	0.27	9.1	1.25
EC2SB-05S05 EC2SB-12S05 EC2SB-24S05 EC2SB-48S05	5.0	2.32	2.32	0	8.2	2.5
EC2SB-05S12 EC2SB-12S12 EC2SB-24S12 EC2SB-48S12	12.0	6.8	2.4	2.32	22	2.5
EC2SB-05S15 EC2SB-12S15 EC2SB-24S15 EC2SB-48S15	15.0	8.06	2.38	3.9	22	2.5

Table 1 – Trim up and Trim down Resistor Values  
For example, to trim-up the output voltage of 5.0V module

(EC2SB12S05) by 10% to 5.5V, R trim-up is calculated as follows:

$$V_o - V_{o, nom} = 5.5 - 5.0 = 0.5V$$

$$R1 = 2.32 \text{ Kohm}$$

$$R2 = 2.32 \text{ Kohm}$$

$$R3 = 0 \text{ Kohm}$$

$$R_t = 8.2 \text{ Kohm}, V_r = 2.5$$

$$R_{trim-up} = \left( \frac{2.5 \times 2.32 \times (2.32 + 0)}{0.5 \times 2.32} \right) - 8.2 = 3.06(K\Omega)$$

The value of R trim-down defined as:

$$R_{trim-down} = R1 \times \left( \frac{V_r \times R1}{(V_{o, nom} - V_o) \times R2} - 1 \right) - R_t \text{ (K}\Omega\text{)}$$

Where:

R trim-down is the external resistor in Kohm.

Vo, nom is the nominal output voltage.

Vo is the desired output voltage.

R1, Rt, R2, R3 and Vr are internal to the unit and are defined in Table 1

For example, to trim-down the output voltage of 5.0V module

(EC2SB12S05) by 10% to 4.5V, R trim-down is calculated as follows:

$$V_{o, nom} - V_o = 5.0 - 4.5 = 0.5V$$

$$R1 = 2.32 \text{ Kohm}$$

$$R2 = 2.32 \text{ Kohm}$$

$$R3 = 0 \text{ Kohm}$$

$$R_t = 8.2 \text{ Kohm}, V_r = 2.5$$

$$R_{trim-down} = 2.32 \times \left( \frac{(2.5 \times 2.32)}{0.5 \times 2.32} - 1 \right) - 8.2 = 1.08 \text{ (K}\Omega\text{)}$$

### 6.7 Output Ripple and Noise Measurement

The test set-up for noise and ripple measurements is shown in Figure6. A coaxial cable was used to prevent impedance mismatch reflections disturbing the noise readings at higher frequencies. Measurements are taken with output appropriately loaded and all ripple/noise specifications are from D.C. to 20MHz Band Width.

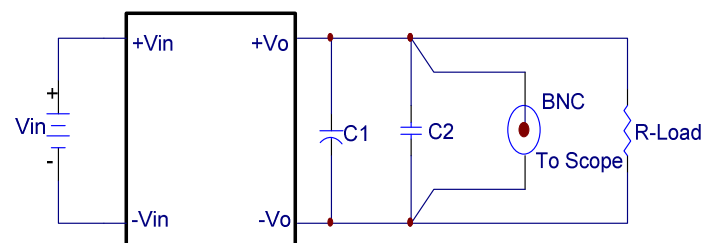

Note: C1: 10uF tantalum capacitor

C2: 1uF Ceramic capacitor

Figure6 Output Voltage Ripple and Noise Measurement Set-Up

### 6.8 Output Capacitance

The EC2SB series converters provide unconditional stability with or without external capacitors. For good transient response low ESR output capacitors should be located close to the point of load. These series converters are designed to work with load capacitance to see technical specifications



# EC2SB 10W Isolated DC-DC Converters

## Application Note V12 November 2020

### 7. Safety & EMC

#### 7.1 Input Fusing and Safety Considerations.

The EC2SB series converters have not an internal fuse. However, to achieve maximum safety and system protection, always use an input line fuse. We recommended a fast acting fuse, 5A for 5V<sub>in</sub>, 4A for 12V<sub>in</sub> models, 2A for 24V<sub>in</sub> models, 1A 48V<sub>in</sub> modules. Figure 7 circuit is recommended by a Transient Voltage Suppressor diode across the input terminal to protect the unit against surge or spike voltage and input reverse voltage.

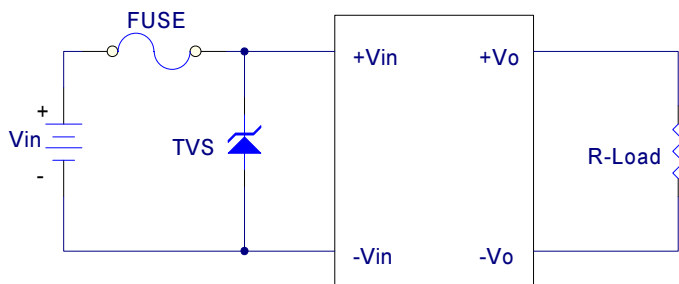

Figure7 Input Protection

#### 7.2 EMC Considerations

EMI Test standard: EN55032 Class A and Class B Conducted Emission

Test Condition: Input Voltage: Nominal, Output Load: Full Load

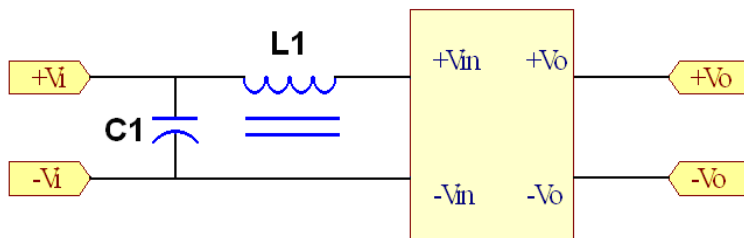

Figure 8 Connection circuit for conducted EMI testing



# EC2SB 10W Isolated DC-DC Converters

## Application Note V12 November 2020

Model No.	EN55032 Class A		EN55032 Class B	
	C1	L1	C1	L1
EC2SB-05S33	NC	Short	TBD	TBD
EC2SB-05S05	NC	Short	TBD	TBD
EC2SB-05S12	NC	Short	TBD	TBD
EC2SB-05S15	NC	Short	TBD	TBD
EC2SB-05D05	NC	Short	TBD	TBD
EC2SB-05D12	NC	Short	TBD	TBD
EC2SB-05D15	NC	Short	TBD	TBD
EC2SB-12S33	NC	Short	1uF /100V 1812	3.9uH
EC2SB-12S05	NC	Short	1uF /100V 1812	3.9uH
EC2SB-12S12	NC	Short	1uF /100V 1812	3.9uH
EC2SB-12S15	NC	Short	1uF /100V 1812	3.9uH
EC2SB-12D05	NC	Short	1uF /100V 1812	3.9uH
EC2SB-12D12	NC	Short	1uF /100V 1812	3.9uH
EC2SB-12D15	NC	Short	1uF /100V 1812	3.9uH
EC2SB-24S33	NC	Short	1uF /100V 1812	3.9uH
EC2SB-24S05	NC	Short	1uF /100V 1812	3.9uH
EC2SB-24S12	NC	Short	1uF /100V 1812	3.9uH
EC2SB-24S15	NC	Short	1uF /100V 1812	3.9uH
EC2SB-24D05	NC	Short	1uF /100V 1812	3.9uH
EC2SB-24D12	NC	Short	1uF /100V 1812	3.9uH
EC2SB-24D15	NC	Short	1uF /100V 1812	3.9uH
EC2SB-48S33	NC	Short	1uF /100V 1812	3.9uH
EC2SB-48S05	NC	Short	1uF /100V 1812	3.9uH
EC2SB-48S12	NC	Short	1uF /100V 1812	3.9uH
EC2SB-48S15	NC	Short	1uF /100V 1812	3.9uH
EC2SB-48D05	NC	Short	1uF /100V 1812	3.9uH
EC2SB-48D12	NC	Short	1uF /100V 1812	3.9uH
EC2SB-48D15	NC	Short	1uF /100V 1812	3.9uH

Note: All of capacitors are ceramic capacitors.



# EC2SB 10W Isolated DC-DC Converters

## Application Note V12 November 2020

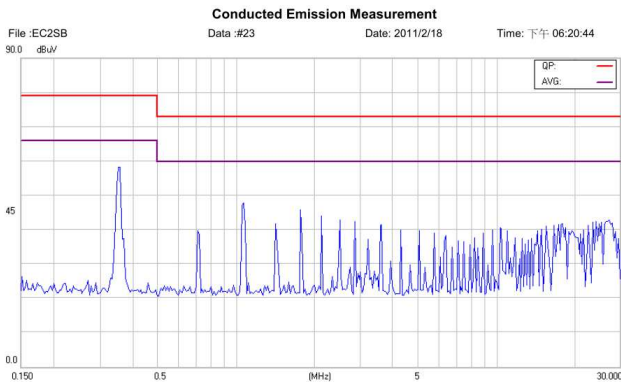

Figure 9 Conducted Class A of EC2SB-05S33

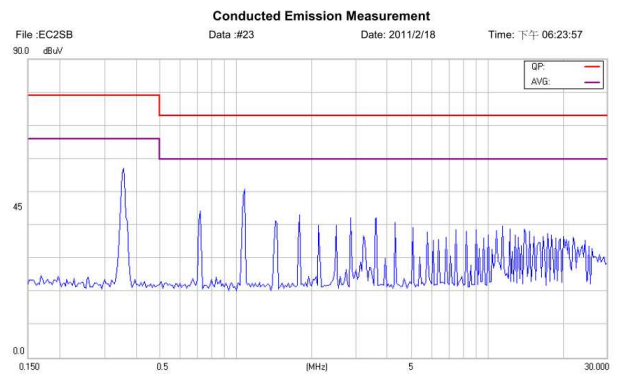

Figure 10 Conducted Class A of EC2SB-05S05

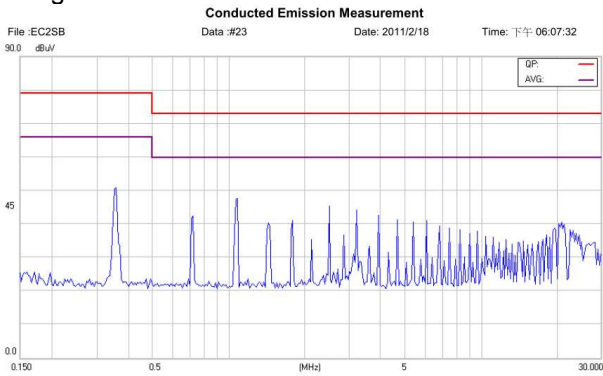

Figure 11 Conducted Class A of EC2SB-05S12

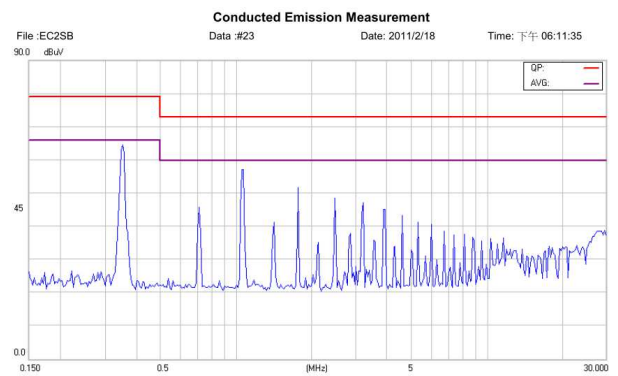

Figure 12 Conducted Class A of EC2SB-05S15

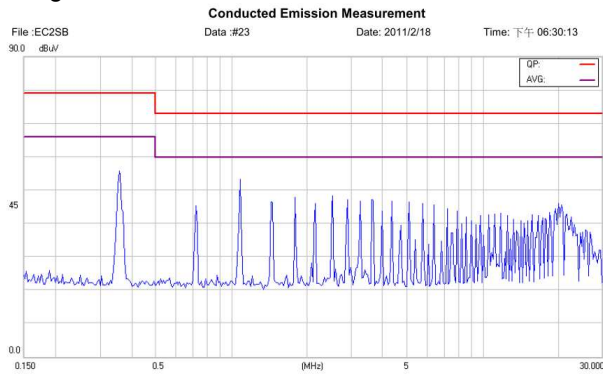

Figure 13 Conducted Class A of EC2SB-05D05

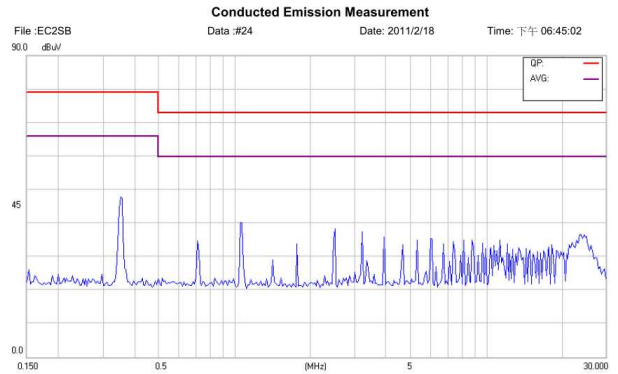

Figure 14 Conducted Class A of EC2SB-05D12

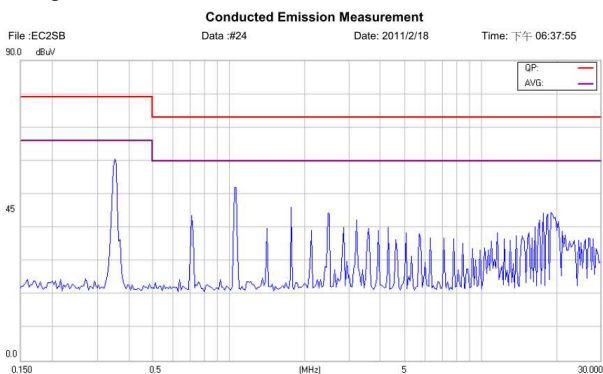

Figure 15 Conducted Class A of EC2SB-05D15

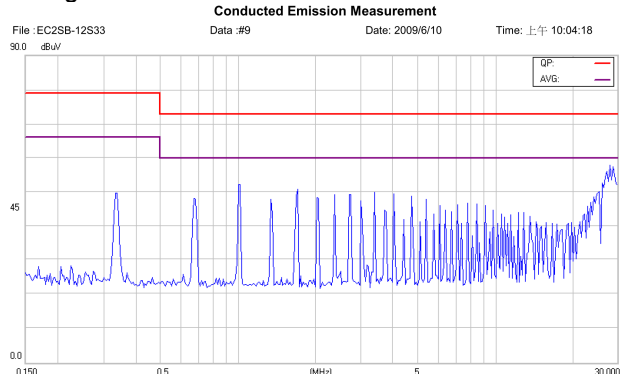

Figure 16 Conducted Class A of EC2SB-12S33



# EC2SB 10W Isolated DC-DC Converters

## Application Note V12 November 2020

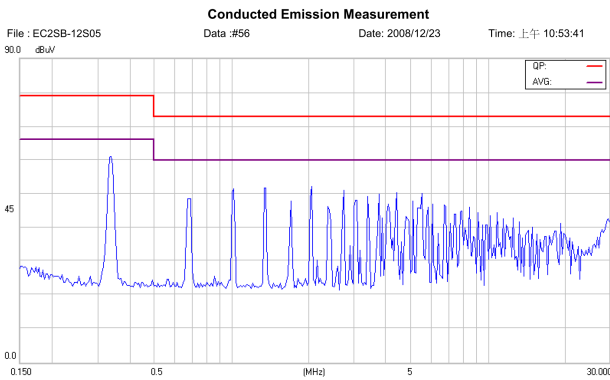

Figure 17 Conducted Class A of EC2SB-12S05

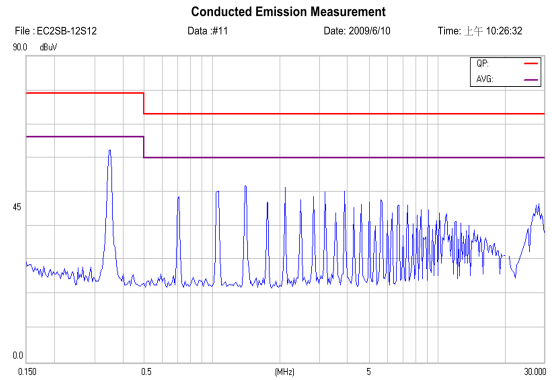

Figure 18 Conducted Class A of EC2SB-12S12

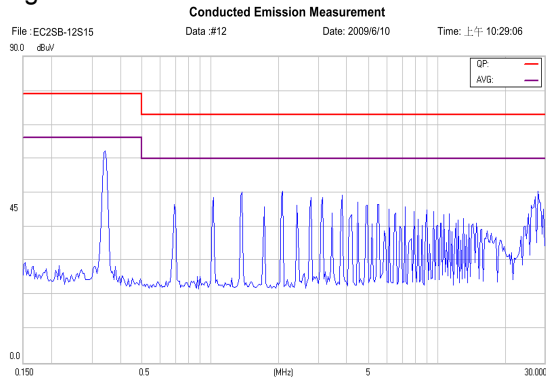

Figure 19 Conducted Class A of EC2SB-12S15

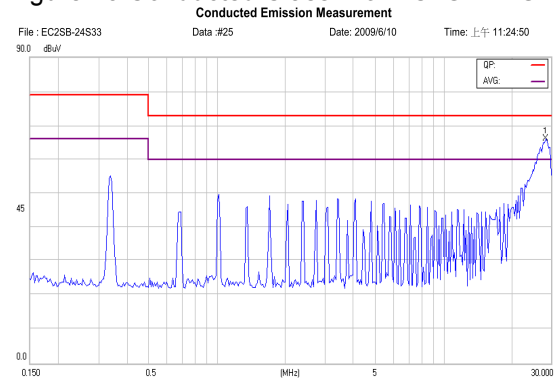

Figure 20 Conducted Class A of EC2SB-24S33

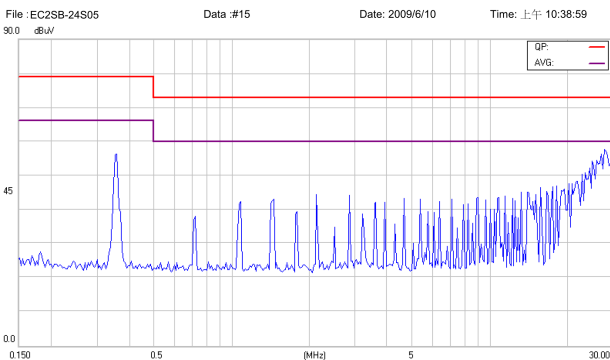

Figure 21 Conducted Class A of EC2SB-24S05

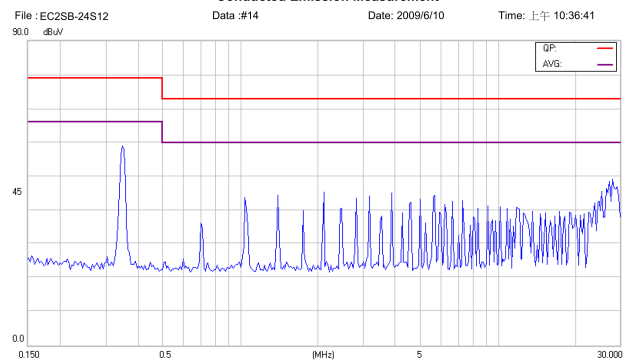

Figure 22 Conducted Class A of EC2SB-24S12

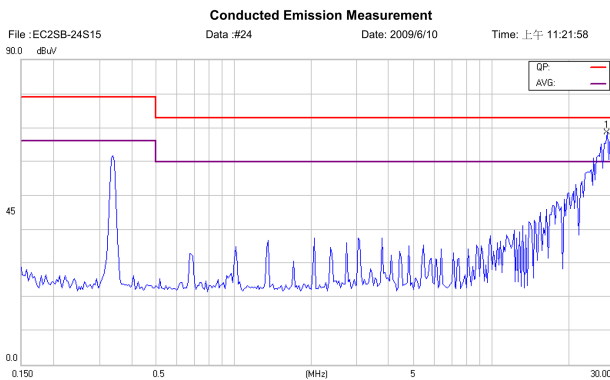

Figure 23 Conducted Class A of EC2SB-24S15

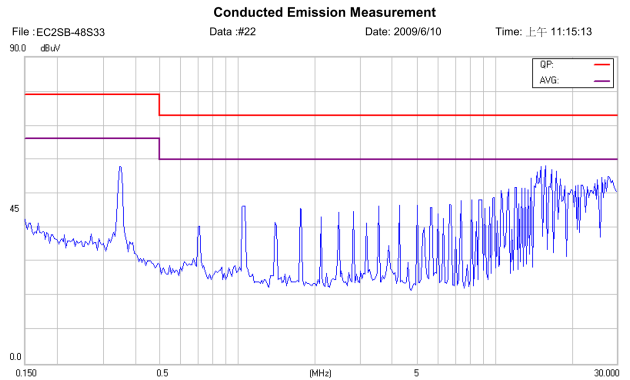

Figure 24 Conducted Class A of EC2SB-48S33



# EC2SB 10W Isolated DC-DC Converters

## Application Note V12 November 2020

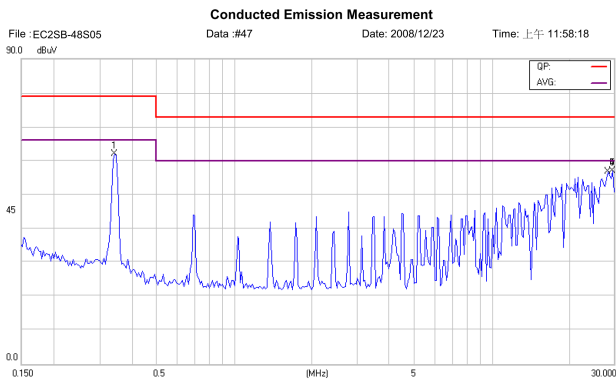

Figure 25 Conducted Class A of EC2SB-48S05

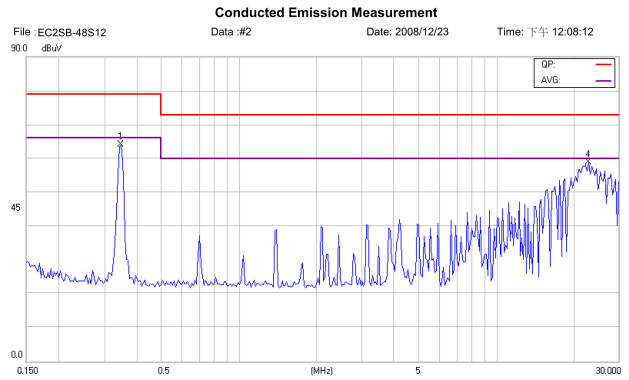

Figure 26 Conducted Class A of EC2SB-48S12

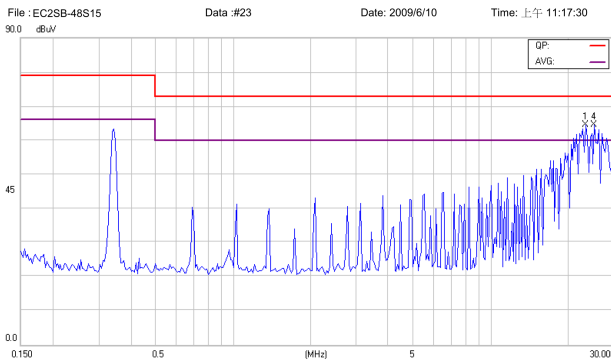

Figure 27 Conducted Class A of EC2SB-48S15

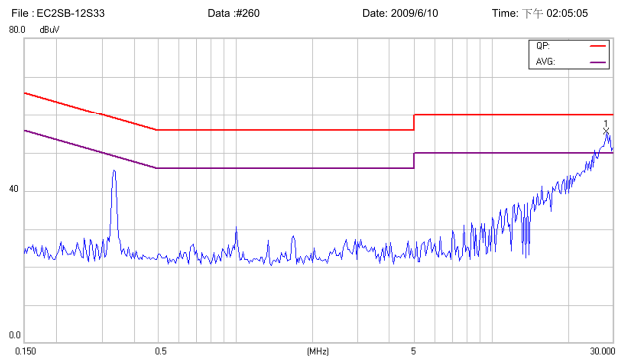

Figure 28 Conducted Class B of EC2SB-12S33

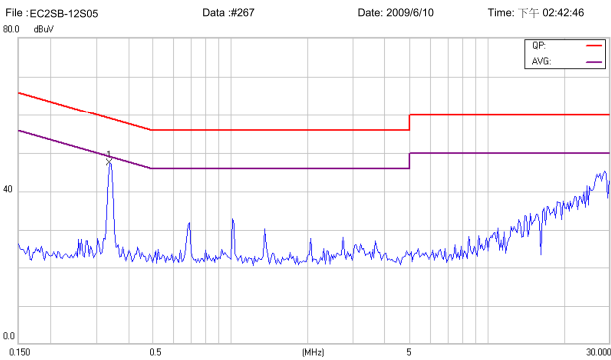

Figure 29 Conducted Class B of EC2SB-12S05

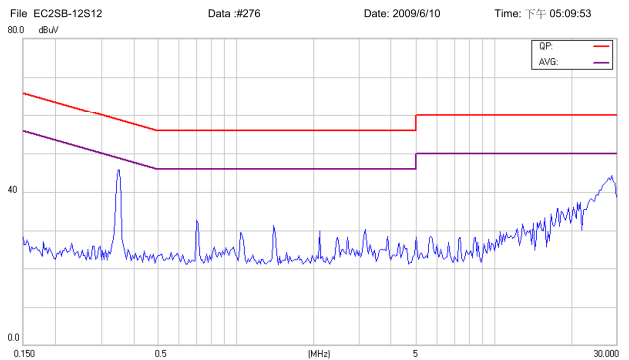

Figure 30 Conducted Class B of EC2SB-12S12

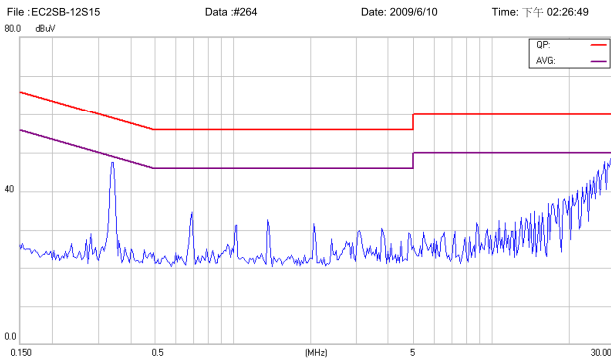

Figure 31 Conducted Class B of EC2SB-12S15

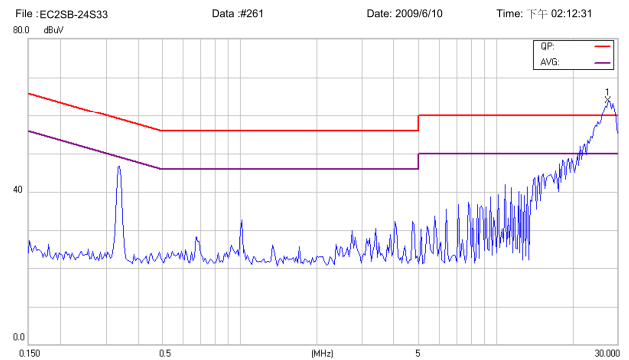

Figure 32 Conducted Class B of EC2SB-24S33



# EC2SB 10W Isolated DC-DC Converters

## Application Note V12 November 2020

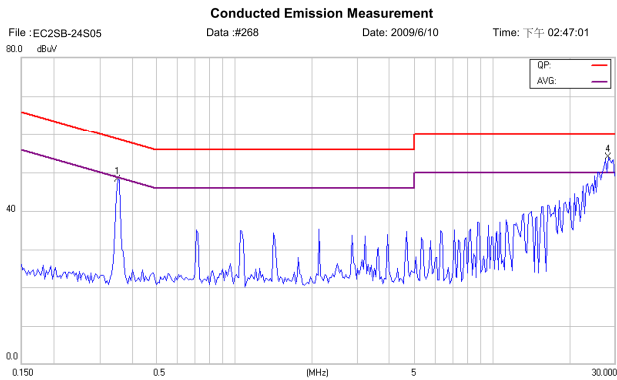

Figure 33 Conducted Class B of EC2SB-24S05

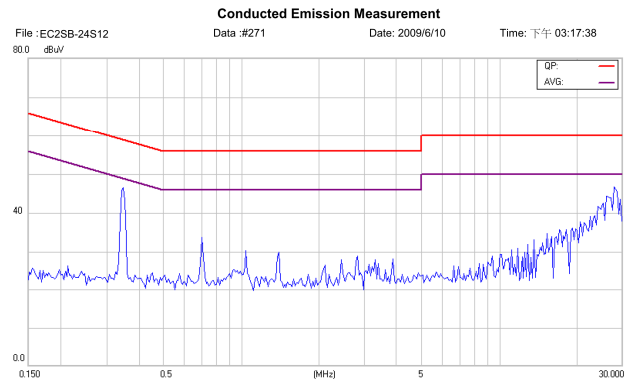

Figure 34 Conducted Class B of EC2SB-24S12

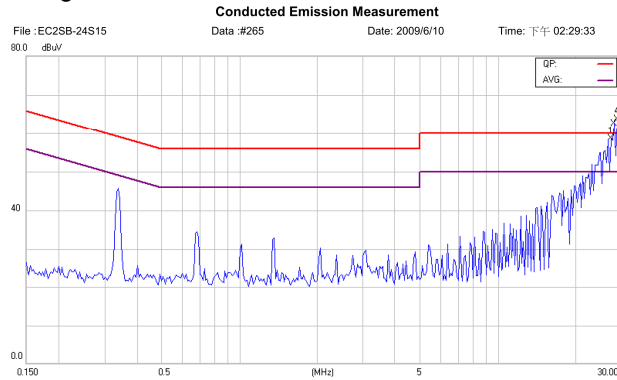

Figure 35 Conducted Class B of EC2SB-24S15

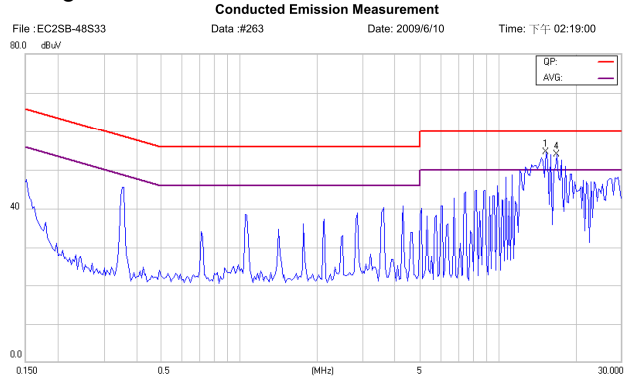

Figure 36 Conducted Class B of EC2SB-48S33

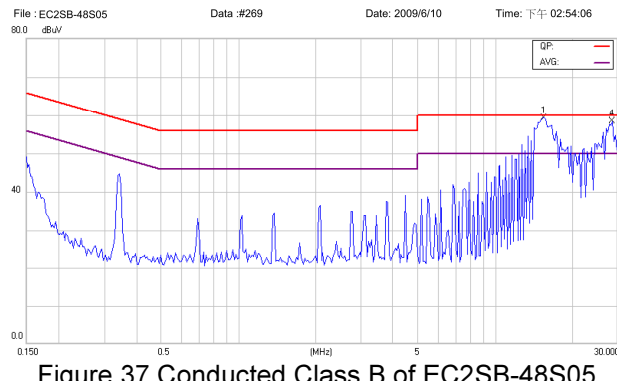

Figure 37 Conducted Class B of EC2SB-48S05

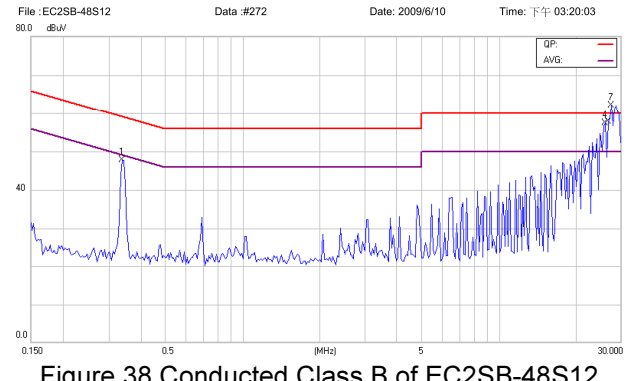

Figure 38 Conducted Class B of EC2SB-48S12

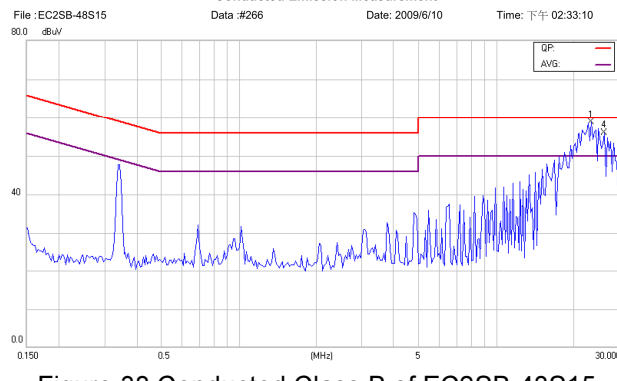

Figure 38 Conducted Class B of EC2SB-48S15





# EC2SB 10W Isolated DC-DC Converters

## Application Note V12 November 2020

### 8. Part Number

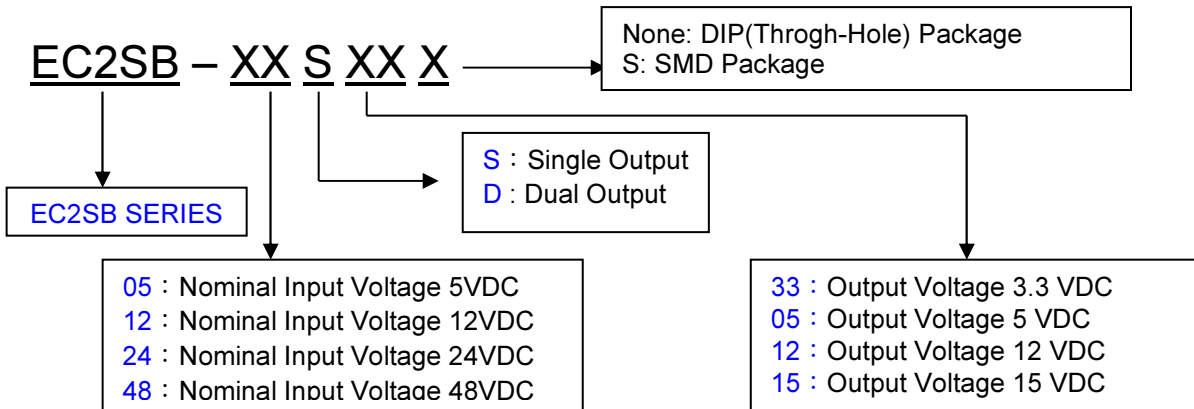

### 9. Mechanical Specifications

NOTE: Pin Size is 0.04±0.004 Inch (1.0±0.1 mm)DIA  
All Dimensions In Inches (mm)  
Tolerances Inches: X.XX= ±0.02 , X.XXX= ±0.010  
Millimeters: X.X= ±0.5 , X.XX=±0.25

#### THROUGH-HOLE PACKAGE

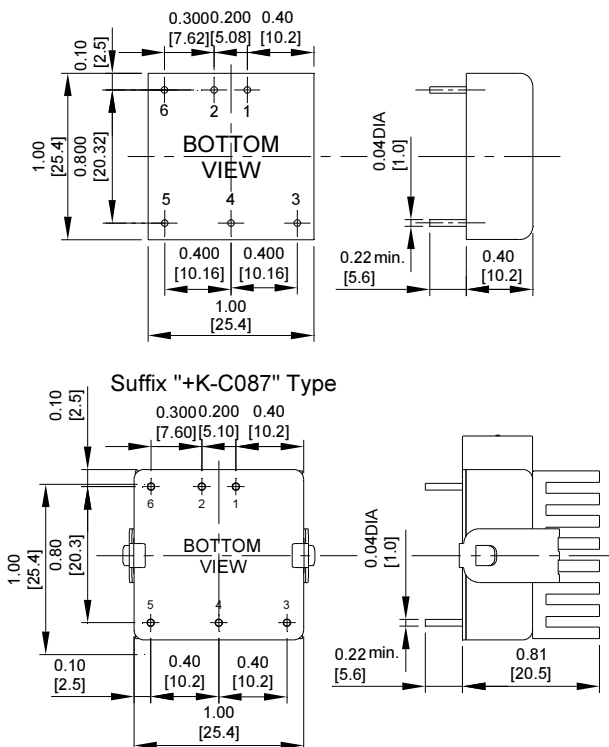

Pin	PIN CONNECTION	
	Single	Dual
1	+Input	+Input
2	-Input	-Input
3	+V Output	+V Output
4	Trim	Common
5	-V Output	-V Output
6	Remote	Remote

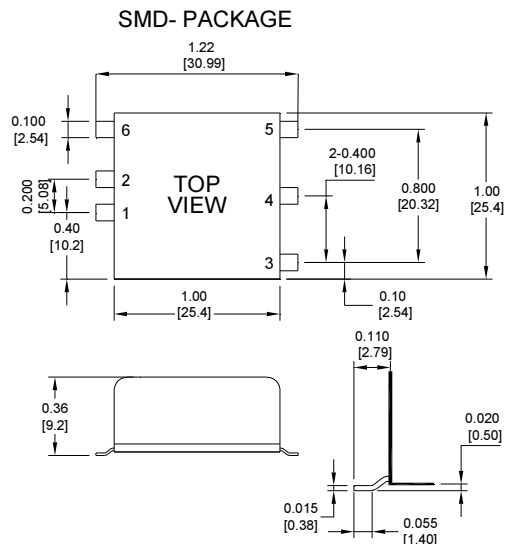

## CINCON ELECTRONICS CO., LTD.

#### Headquarter Office:

14F, No.306, Sec.4, Hsin Yi Rd.,  
Taipei, Taiwan  
Tel: 886-2-27086210  
Fax: 886-2-27029852  
E-mail: [sales@cincon.com.tw](mailto:sales@cincon.com.tw)  
Web Site: <http://www.cincon.com>

#### Factory:

No. 8-1, Fu Kong Rd.,  
Fu Hsing Industrial Park  
Fu Hsing Hsiang, ChangHua Hsien,  
Taiwan  
Tel: 886-4-7690261  
Fax: 886-4-7698031

#### Cincon American Office:

1655 Mesa Verde Ave, Ste 180,  
Ventura, CA 93003  
Tel: 805-639-3350  
Fax: 805-639-4101  
E-mail: [info@cincon.com](mailto:info@cincon.com)