



# EC7AW18 ECRT/EDRT Series Application Note V10

## ISOLATED DC-DC CONVERTER CHASSIS MOUNT EC7AW18 ECRT/EDRT SERIES APPLICATION NOTE



### Approved By:

Department	Approved By	Checked By	Written By
Research and Development Department	Jacky	Danny	Wade
Quality Assurance Department	Benny	JoJo	



# EC7AW18 ECRT/EDRT Series

## Application Note V10

---

### Contents

1. Introduction .....	3
2. Pin Function Description .....	3
3. Terminal Block .....	3
4. Connection for Standard Use .....	4
5. Test Set-Up .....	4
6. Features and Functions .....	4
6.1 UVLO (Under Voltage Lock Out) .....	4
6.2 Over Current/Short Circuit Protection .....	5
6.3 Output Over Voltage Protection .....	5
6.4 Remote On/Off .....	5
7. Input / Output Considerations .....	5
7.1 Hold Up Time .....	5
7.2 Inrush Current Limiter .....	6
7.3 Output Ripple and Noise .....	6
7.4 Output Capacitance .....	6
8. Series and Parallel Operation .....	7
8.1 Series Operation .....	7
8.2 Parallel Operation .....	7
9. Thermal Design .....	8
9.1 Operating Temperature Range .....	8
9.2 Convection Requirements for Cooling .....	8
9.3 Thermal Considerations .....	8
9.4 Power Derating .....	8
10. Safety & EMC .....	9
10.1 Input Fusing and Safety Considerations .....	9
10.2 EMC Considerations .....	10



# EC7AW18 ECRT/EDRT Series

## Application Note V10

### 1. Introduction

The EC7AW18 ECRT/EDRT series of chassis mountable DC-DC converters offers 10 watts of output power @ output voltages of 5, 12, 15,  $\pm 5$ ,  $\pm 12$ ,  $\pm 15$ VDC. It has a wide (16:1) input voltage range of 10 to 160VDC (72VDC nominal) and 3000VAC reinforced isolation.

High efficiency up to 87%, allowing case operating temperature range of  $-40^{\circ}\text{C}$  to  $100^{\circ}\text{C}$ . Very low no load power consumption (6mA), an ideal solution for energy critical systems. LED indicator for power on.

Compliant with EN55032, EN55035, EN50155, EN45545, EN50121-3-2. The standard control functions include negative remote on/off logic.

Fully protected against input UVLO (under voltage lock out), input reverse polarity, output over-current, output over-voltage and continuous short circuit conditions.

EC7AW18 ECRT/EDRT series is designed primarily for common railway applications of 24V, 36V, 48V, 72V, 96V, 110V nominal voltage and also suitable for distributed power architectures, telecommunications, battery operated equipment and industrial applications.

### 2. Pin Function Description

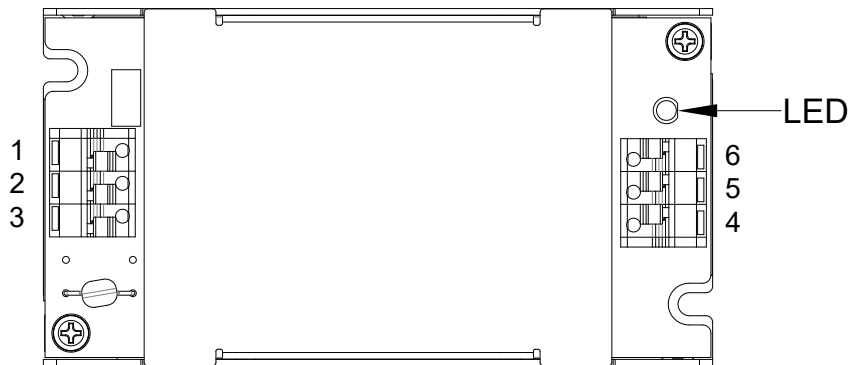

No	Label	Function	Description	Reference
1	+Vi	+V Input	Positive Supply Input	<b>Section 7.1/7.2</b>
2	-Vi	-V Input	Negative Supply Input	<b>Section 7.1/7.2</b>
3	Rem	Remote	External Remote On/Off Control	<b>Section 6.4</b>

#### Single Output

4	NA	NA	Not Applicable	
5	-Vo	-V Output	Negative Power Output	<b>Section 7.3/7.4</b>
6	+Vo	+V Output	Positive Power Output	<b>Section 7.3/7.4</b>

#### Dual Output

4	-Vo	-V Output	Negative Power Output	<b>Section 7.3/7.4</b>
5	Com	Common	Common Power Output	<b>Section 7.3/7.4</b>
6	+Vo	+V Output	Positive Power Output	<b>Section 7.3/7.4</b>

### 3. Terminal Block

Input and Output Terminal Block

Terminal Type	Suitable Electric Wire (AWG)	Current Rating (max.)
DINKLE 0137-1103 or Equivalent	16-26	10A



# EC7AW18 ECRT/EDRT Series Application Note V10

## 4. Connection for Standard Use

The connection for standard use is shown below. An external output capacitors (C1) is recommended to reduce output ripple and noise, output capacitor recommended 1uF ceramic capacitor for all models.

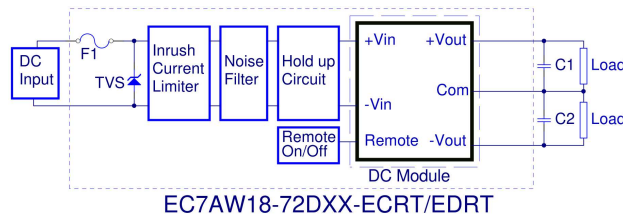
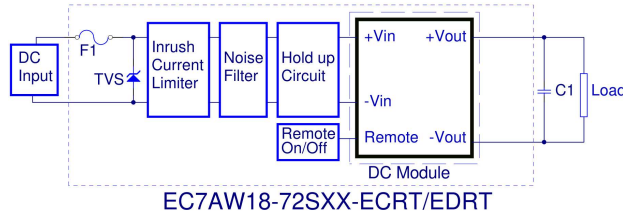

Symbol	Component	Reference
F1, TVS	Input fuse, TVS	<b>Section 10.1</b>
C1, C2	External capacitor on the output side	<b>Section 7.3</b>
Inrush Current Limiter	Internal input Inrush current limiter	<b>Section 7.2</b>
Noise Filter	Internal input noise filter	<b>Section 10.2</b>
Hold up Circuit	Internal input hold up circuit	<b>Section 7.1</b>
Remote On/Off	External remote on/off control	<b>Section 6.4</b>

## 5. Test Set-Up

The basic test set-up to measure parameters such as efficiency and load regulation is shown below. When testing the modules under any transient conditions please ensure that the transient response of the source is sufficient to power the equipment under test. We can calculate:

- Efficiency
- Load regulation and line regulation

The value of efficiency is defined as:

$$\eta = \frac{V_o \times I_o}{V_{in} \times I_{in}} \times 100\%$$

Where:

- $V_o$  is output voltage,
- $I_o$  is output current,
- $V_{in}$  is input voltage,
- $I_{in}$  is input current.

The value of load regulation is defined as:

$$Load\ reg. = \frac{V_{FL} - V_{NL}}{V_{NL}} \times 100\%$$

Where:

- $V_{FL}$  is the output voltage at full load.
- $V_{NL}$  is the output voltage at no load.

The value of line regulation is defined as:

$$Line\ reg. = \frac{V_{HL} - V_{LL}}{V_{LL}} \times 100\%$$

Where:

- $V_{HL}$  is the output voltage of maximum input voltage at full load.
- $V_{LL}$  is the output voltage of minimum input voltage at full load.

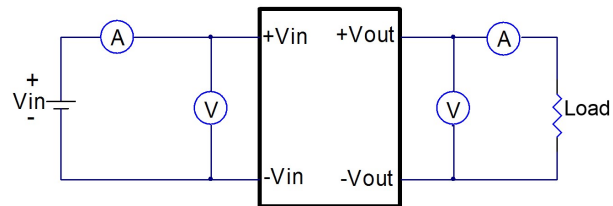

EC7AW18 ECRT/EDRT Series Test Setup

## 6. Features and Functions

### 6.1 UVLO (Under Voltage Lock Out)

Input under voltage lock out is standard on the EC7AW18 ECRT/EDRT series unit. The unit will shut down when the input voltage drops below a threshold, and the unit will operate when the input voltage goes above the upper threshold.

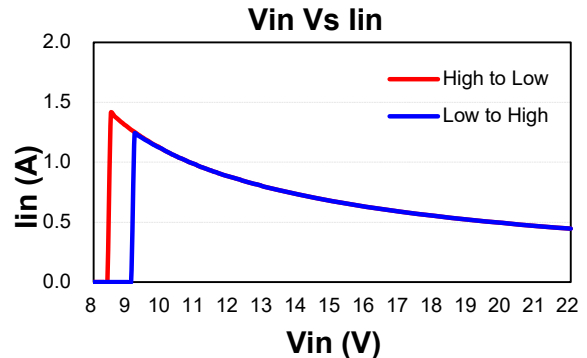



# EC7AW18 ECRT/EDRT Series Application Note V10

## 6.2 Over Current/Short Circuit Protection

All models have internal over current and continuous short circuit protection. The unit operates normally once the fault condition is removed. At the point of current limit inception, the converter will go into hiccup mode protection.

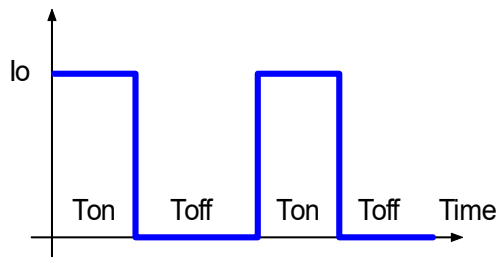
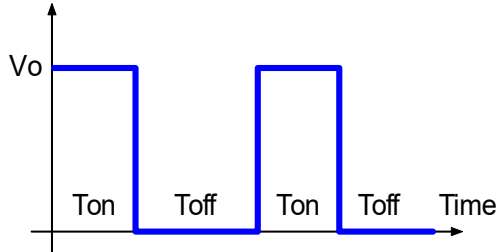

## 6.3 Output Over Voltage Protection

The over-voltage protection consists of a zener diode to limiting the out voltage.

## 6.4 Remote On/Off

The EC7AW18 ECRT/EDRT series allows the user to switch the module on and off electronically with the remote On/Off feature. All models are available in "negative logic" versions. The converter turns off if the remote On/Off pin is high (>3.5Vdc to 12Vdc). Setting the pin low (0 to <1.2Vdc or open circuit) will turn the converter on. The signal level of the remote On/Off input is defined with respect to ground.

If not using the remote On/Off pin, leave the pin open (converter will be on).

Logic State (CN1 Pin 3)	Negative Logic
Logic Low – 0 to 1.2Vdc or Open circuit	Module on
Logic High – 3.5 to 12Vdc	Module off

The converter remote On/Off circuit built-in on input side. The ground pin of input side Remote On/Off circuit is – Vin pin. Inside connection sees below.

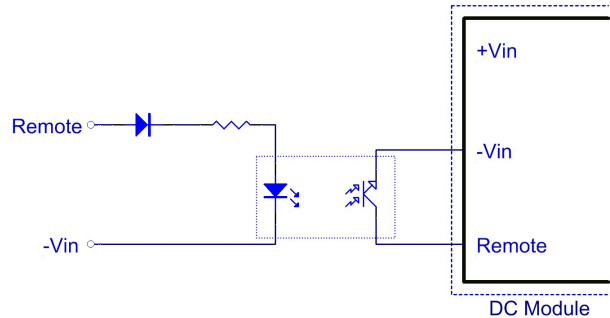

## 7. Input / Output Considerations

### 7.1 Hold Up Time

Hold up time is defined as the duration of time that DC/DC converter output will remain active following a loss of input power.

EC7AW18 ECRT/EDRT series internal with Hold up Bus Capacitor, Input voltage and output power will determine the output hold up time, refer to following figures.

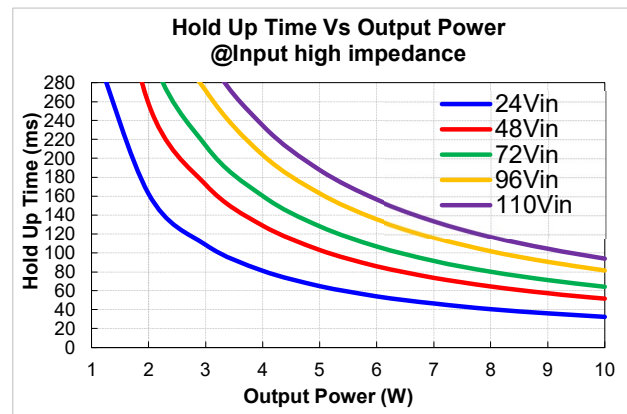
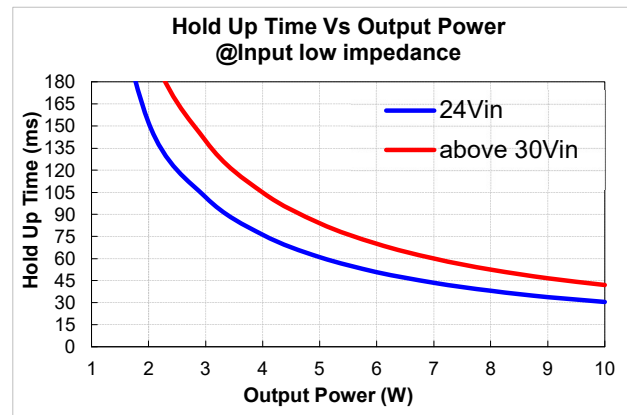



# EC7AW18 ECRT/EDRT Series Application Note V10

## 7.2 Inrush Current Limiter

These modules have inrush current limiter inside, it could reduce the inrush current from the input line to the internal capacitor when the power on.

## 7.3 Output Ripple and Noise

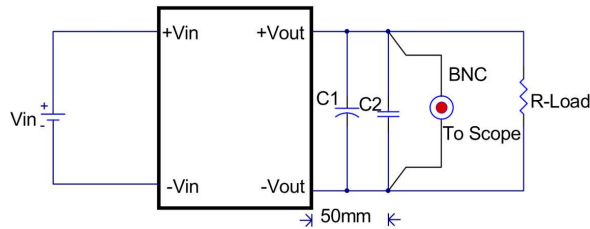

Note:

C1: None

C2: 1uF ceramic capacitor.

EC7AW18-72SXX-ECRT/EDRT

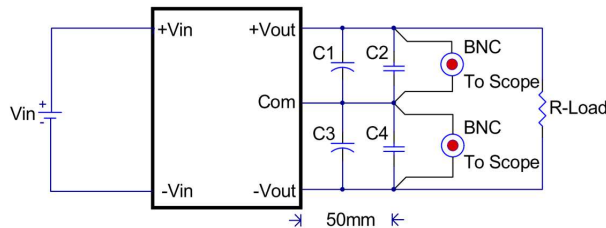

Note:

C1 & C3: None

C2 & C4: 1uF ceramic capacitor.

EC7AW18-72DXX-ECRT/EDRT

Output ripple and noise measured with 1uF ceramic capacitors across output. A 20 MHz bandwidth oscilloscope is normally used for the measurement.

The conventional ground clip on an oscilloscope probe should never be used in this kind of measurement. This clip, when placed in a field of radiated high frequency energy, acts as an antenna or inductive pickup loop, creating an extraneous voltage that is not part of the output noise of the converter.



Another method is shown in below, in case of coaxial-cable/BNC is not available. The noise pickup is eliminated by pressing scope probe ground ring directly against the -Vout terminal while the tip contacts the +Vout terminal. This makes the shortest possible connection across the output terminals.

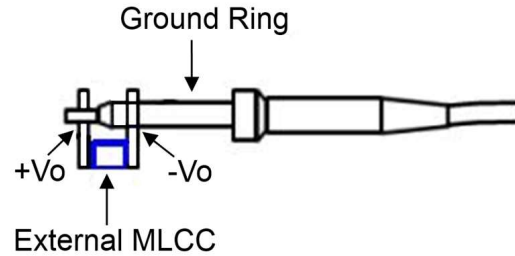

## 7.4 Output Capacitance

The EC7AW18 ECRT/EDRT series converters provide unconditional stability with or without external capacitors. For good transient response, low ESR output capacitors should be located close to the point of load (<100mm). PCB design emphasizes low resistance and inductance tracks in consideration of high current applications. Output capacitors with their associated ESR values have an impact on loop stability and bandwidth. Cincon's converters are designed to work with load capacitance to see technical specifications.



# EC7AW18 ECRT/EDRT Series Application Note V10

## 8. Series and Parallel Operation

### 8.1 Series Operation

Series operation is possible by connecting the outputs two or more units. Connection is shown in below. The output current in series connection should be lower than the lowest rate current in each power module.

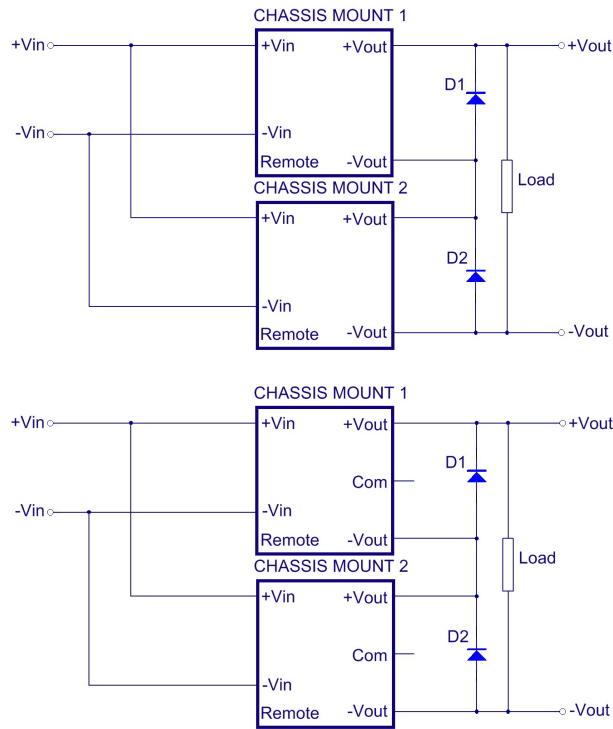

**Simple Series Operation Connect Circuit**

**Note:**

Recommend Schottky diode (D1, D2) be connected across the output of each series connected converter, so that if one converter shuts down for any reason, then the output stage won't be thermally overstressed. Without this external diode, the output stage of the shut-down converter could carry the load current provided by the other series converters, with its MOSFETs conducting through the body diodes. The MOSFETs could then be overstressed and fail. The external diode should be capable of handling the full load current for as long as the application is expected to run with any unit shut down. Series for  $\pm$ output operation is possible by connecting the outputs two units, as shown in the schematic below.

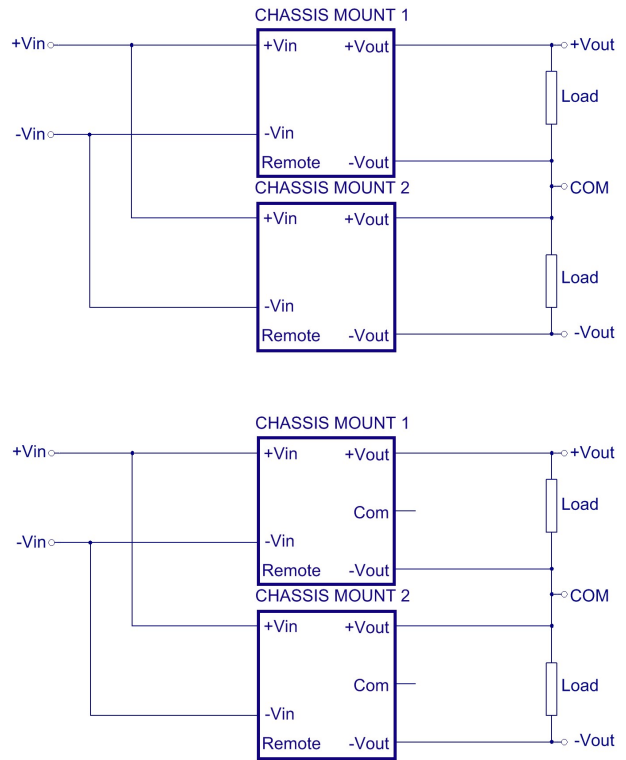

**Simple  $\pm$ Output Operation Connect Circuit**

### 8.2 Parallel Operation

The EC7AW18 ECRT/EDRT series parallel operation is not possible.



# EC7AW18 ECRT/EDRT Series Application Note V10

## 9. Thermal Design

### 9.1 Operating Temperature Range

The EC7AW18 ECRT/EDRT series converters can be operated within a wide case temperature range of  $-40^{\circ}\text{C}$  to  $100^{\circ}\text{C}$ . Consideration must be given to the derating curves when ascertaining maximum power that can be drawn from the converter. The maximum power drawn from chassis mount models is influenced by usual factors, such as:

- Input voltage range
- Output load current
- Forced air or natural convection

### 9.2 Convection Requirements for Cooling

To predict the approximate cooling needed for the chassis mount module, refer to the power derating curves in **datasheet**. These derating curves are approximations of the ambient temperatures and airflows required to keep the power module temperature below its maximum rating. Once the module is assembled in the actual system, the module's case plate temperature should be monitored to ensure it does not exceed  $100^{\circ}\text{C}$ , case plate temperature measuring point refer to below (thus verifying proper cooling).

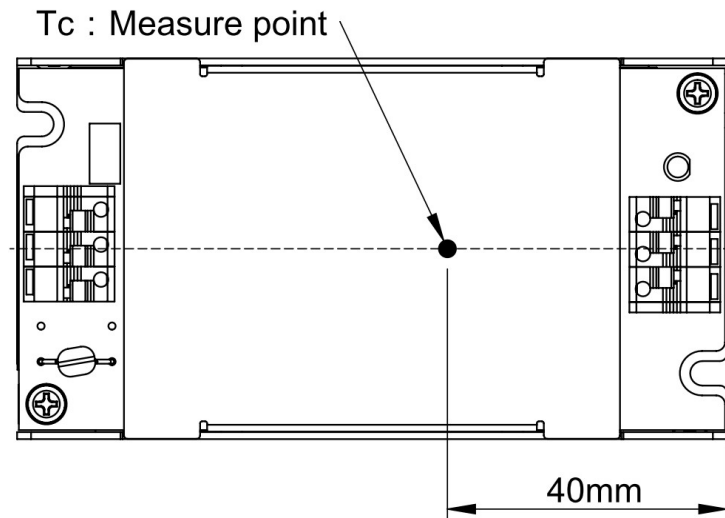

### 9.3 Thermal Considerations

The power module operates in a variety of thermal environments; however, sufficient cooling should be provided to help ensure reliable operation of the unit. Heat is removed by conduction, convection, and radiation to the surrounding environment. The example is presented in **datasheet**. The power output of the module should not be allowed to exceed rated power ( $V_{o\_set} \times I_{o\_max}$ ).

### 9.4 Power Derating

The operating case temperature range of EC7AW18 ECRT/EDRT series is  $-40^{\circ}\text{C}$  to  $+100^{\circ}\text{C}$ . When operating the EC7AW18 ECRT/EDRT series, proper derating or cooling is needed. The maximum case temperature under any operating condition should not exceed  $100^{\circ}\text{C}$  (refer to datasheet).





# EC7AW18 ECRT/EDRT Series Application Note V10

## 10. Safety & EMC

### 10.1 Input Fusing and Safety Considerations

The EC7AW18 ECRT/EDRT series converters have internal fuse. Achieve maximum safety and system protection, Input line fuse specification is 2A time delay. Have a transient voltage suppressor diode (TVS) across the input terminal to protect the unit against surge or spike voltage and input reverse voltage (as shown).

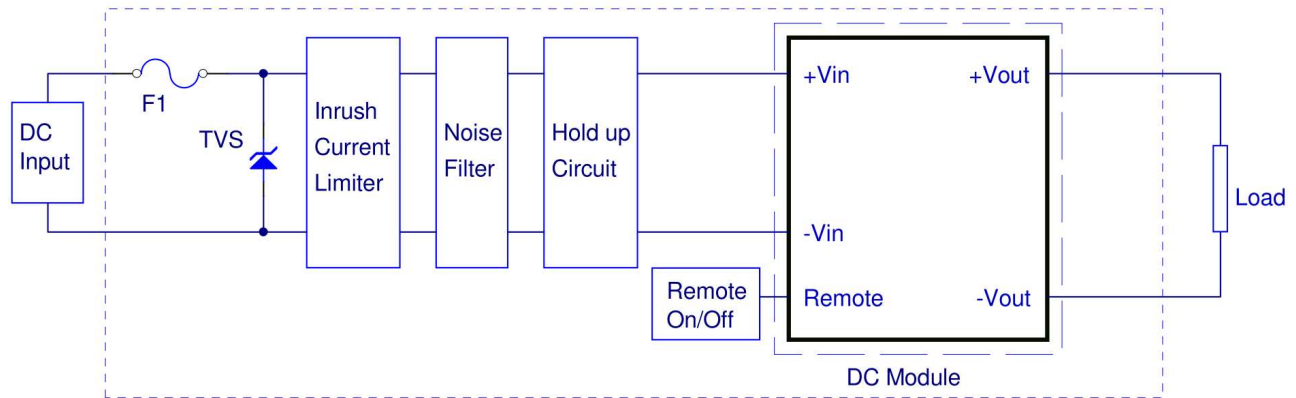

EC7AW18-72SXX-ECRT/EDRT

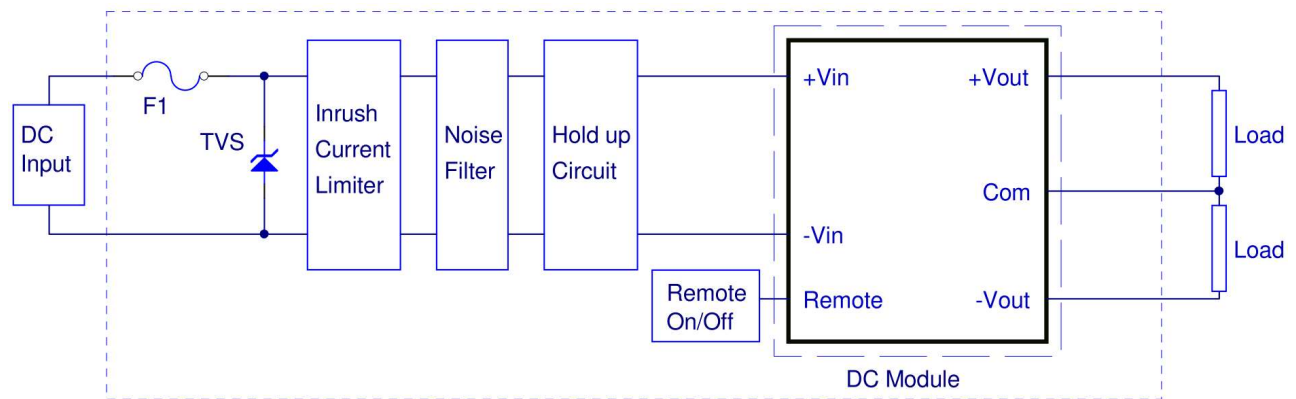

EC7AW18-72DXX-ECRT/EDRT



# EC7AW18 ECRT/EDRT Series Application Note V10

## 10.2 EMC Considerations

EMI Test standard: EN55032 Class A, EN50121-3-2  
 Test Condition: Input Voltage: 110Vdc, Output Load: Full Load

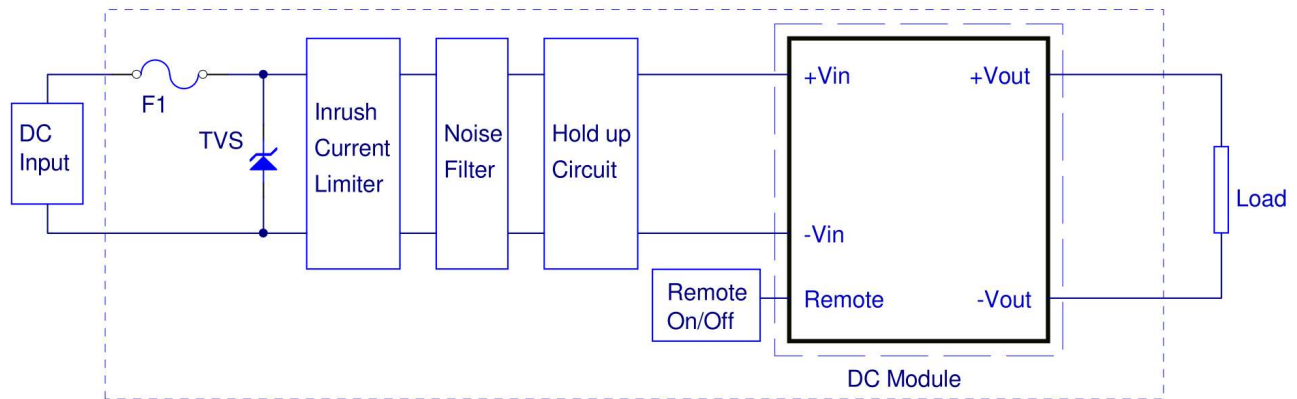

EC7AW18-72SXX-ECRT

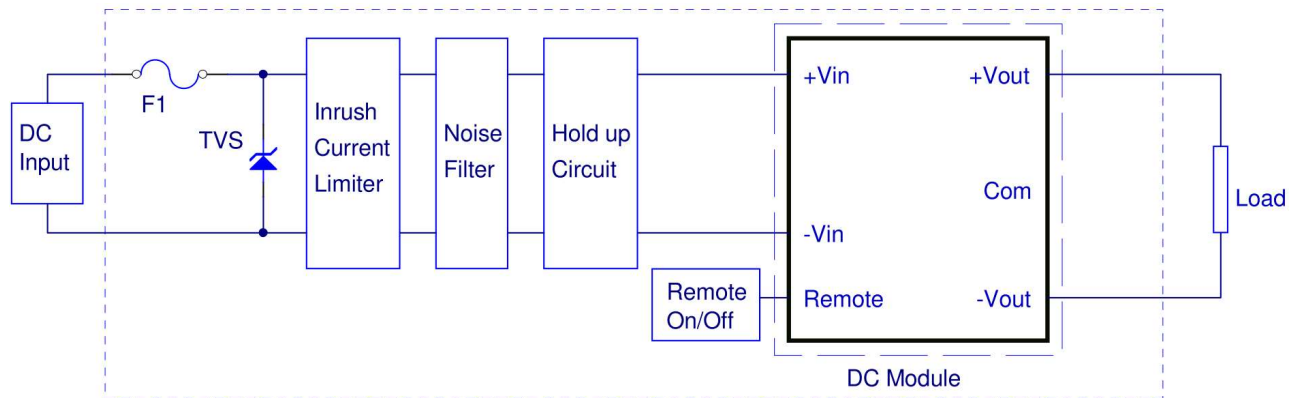

EC7AW18-72DXX-ECRT

Connection circuit for EN55032 & EN50121-3-2 EMI testing



# EC7AW18 ECRT/EDRT Series Application Note V10

## Input Conducted Emission (EN55032):

EC7AW18-72S05-ECRT

Line

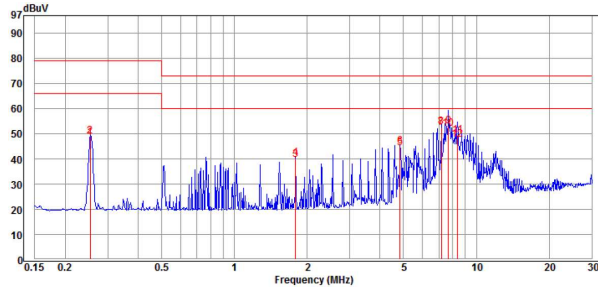

Neutral

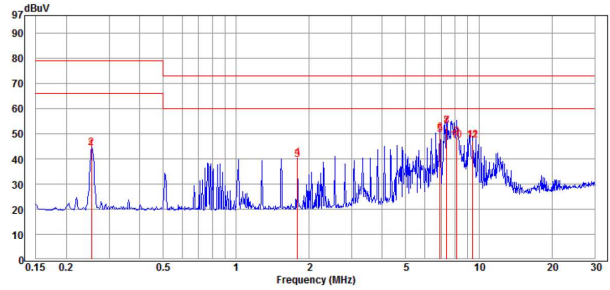

EC7AW18-72S12-ECRT

Line

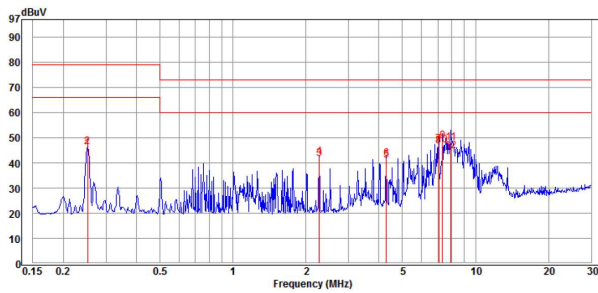

Neutral

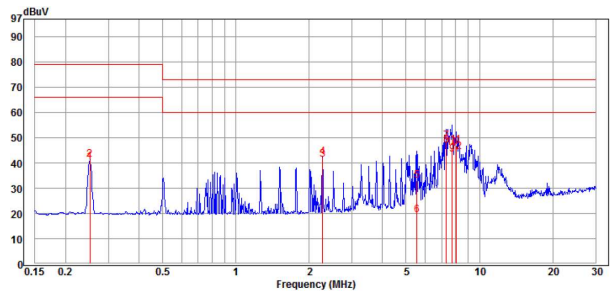

EC7AW18-72S15-ECRT

Line

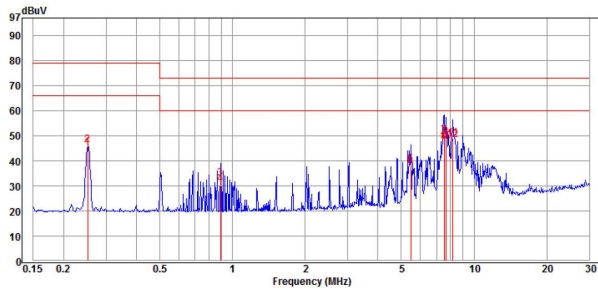

Neutral

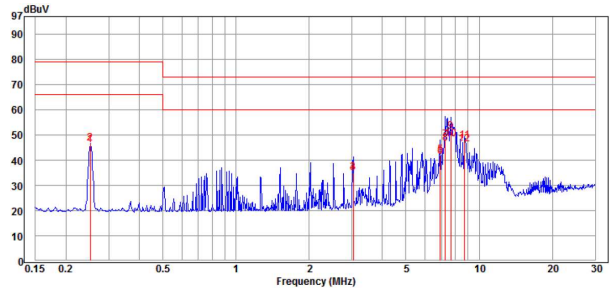

EC7AW18-72D05-ECRT

Line

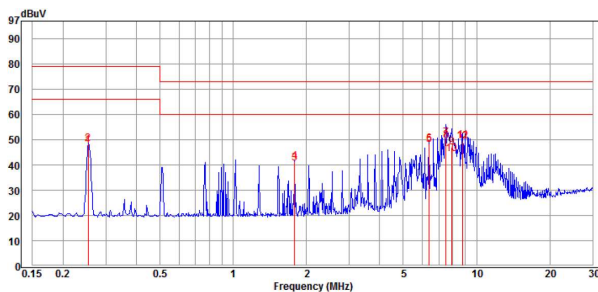

Neutral

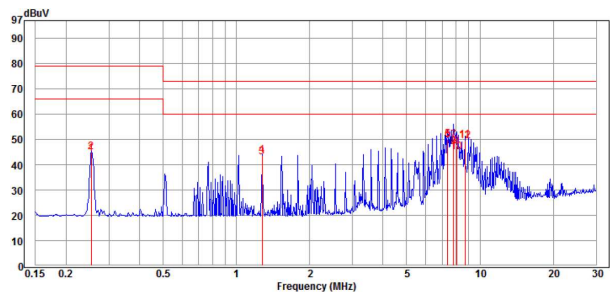



# EC7AW18 ECRT/EDRT Series Application Note V10

## EC7AW18-72D12-ECRT

Line

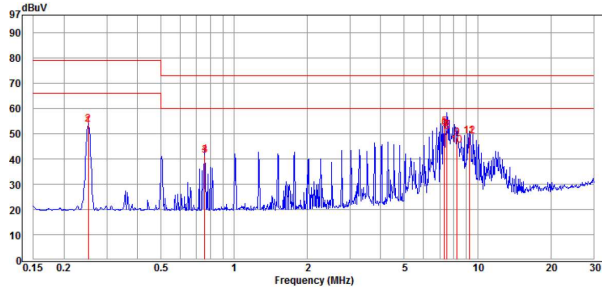

Neutral

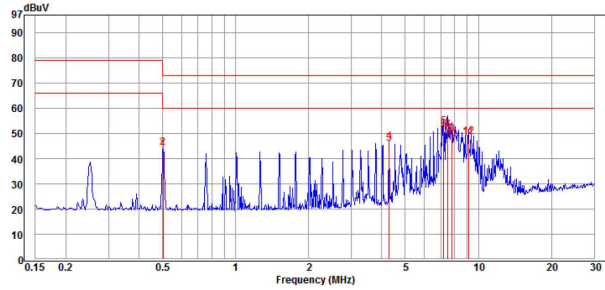

## EC7AW18-72D15-ECRT

Line

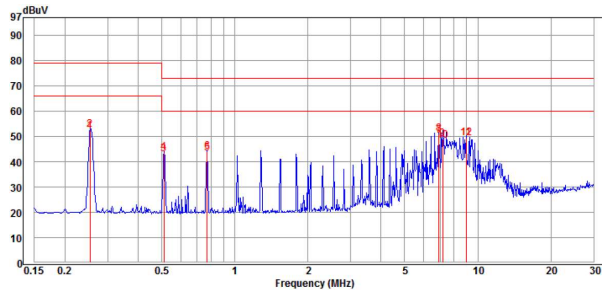

Neutral

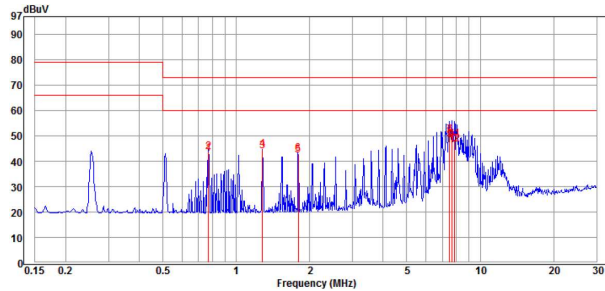

## Input Conducted Emission (EN50121-3-2):

### EC7AW18-72S05-ECRT

Line

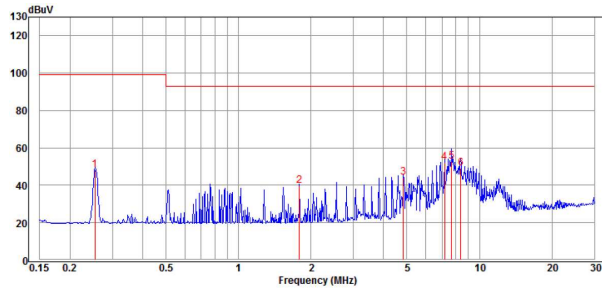

Neutral

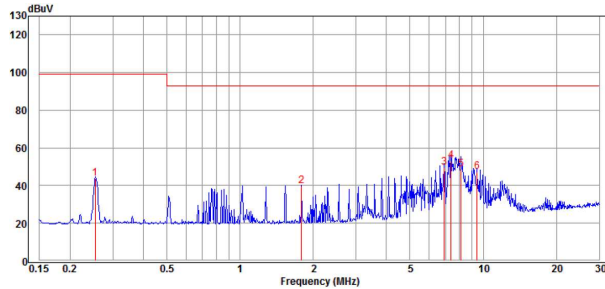

### EC7AW18-72S12-ECRT

Line

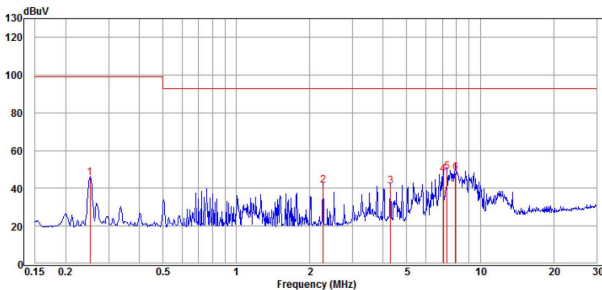

Neutral

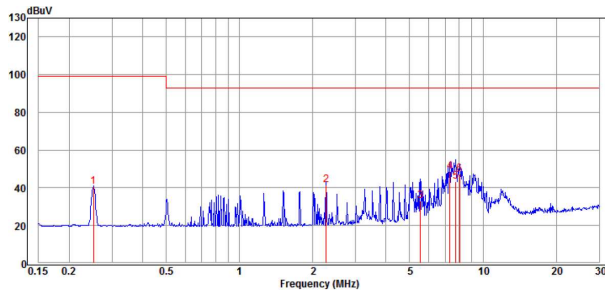



# EC7AW18 ECRT/EDRT Series Application Note V10

## EC7AW18-72S15-ECRT

Line

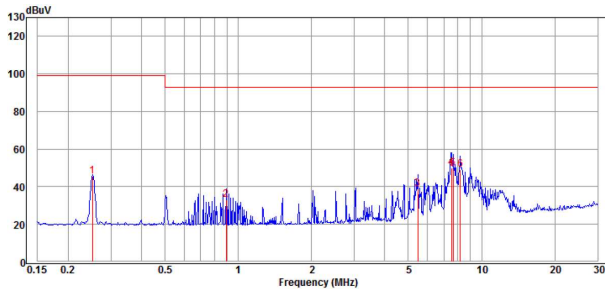

Neutral

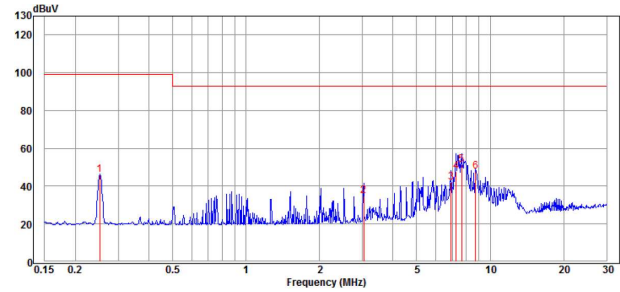

## EC7AW18-72D05-ECRT

Line

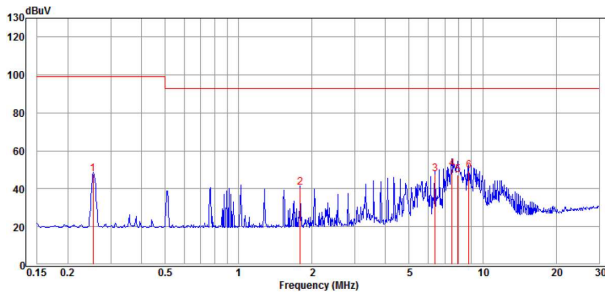

Neutral

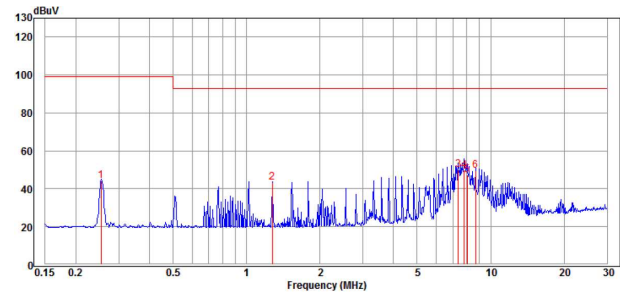

## EC7AW18-72D12-ECRT

Line

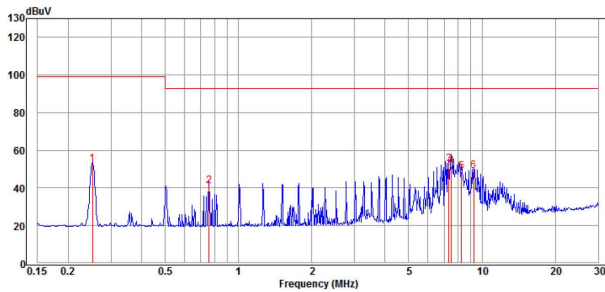

Neutral

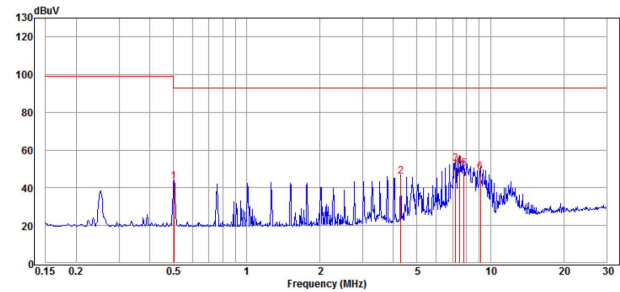

## EC7AW18-72D15-ECRT

Line

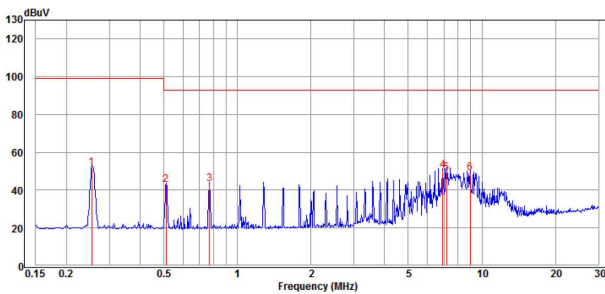

Neutral

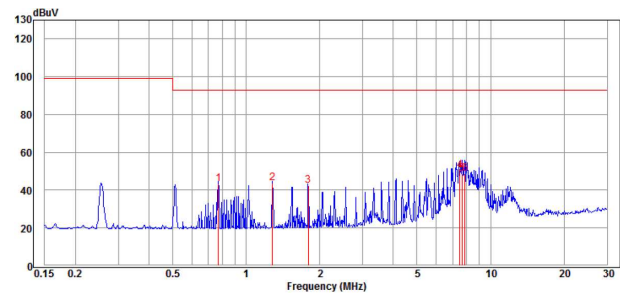



# EC7AW18 ECRT/EDRT Series Application Note V10

## Output Conducted Emission:

EC7AW18-72S05-ECRT

Positive

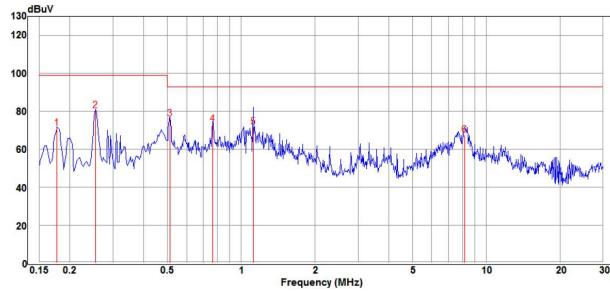

Negative

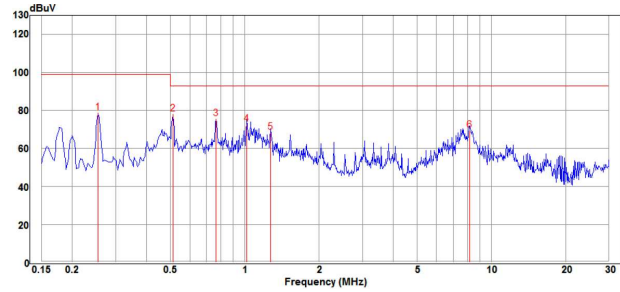

EC7AW18-72S12-ECRT

Positive

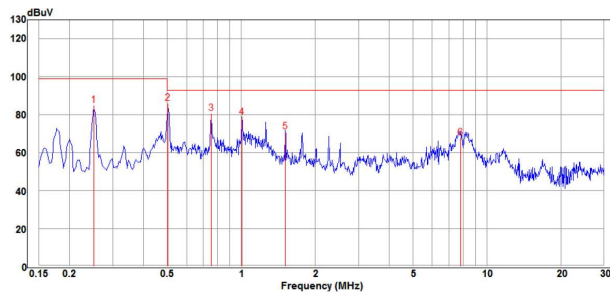

Negative

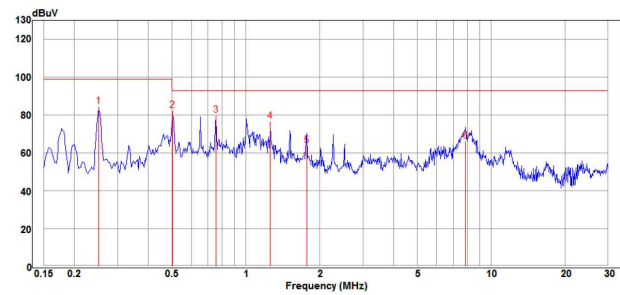

EC7AW18-72S15-ECRT

Positive

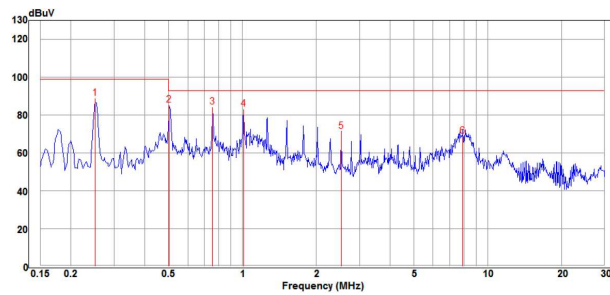

Negative

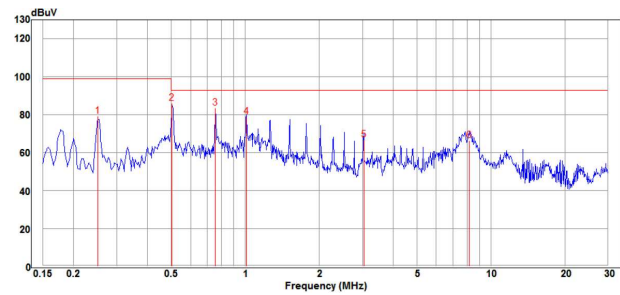

EC7AW18-72D05-ECRT

Positive

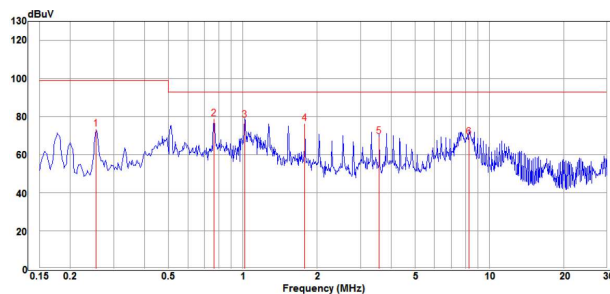

Negative

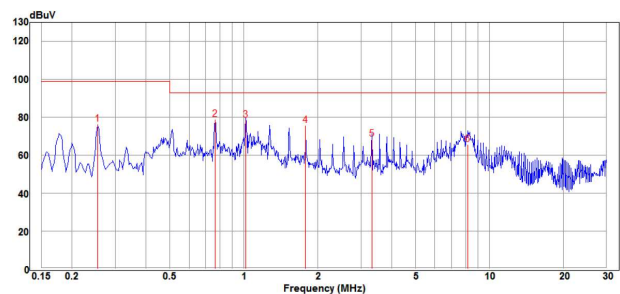





# EC7AW18 ECRT/EDRT Series

## Application Note V10

### EC7AW18-72D12-ECRT

Positive

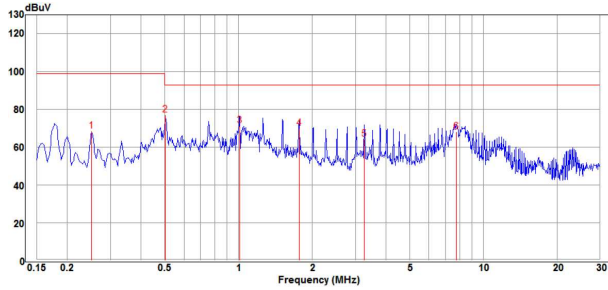

Negative

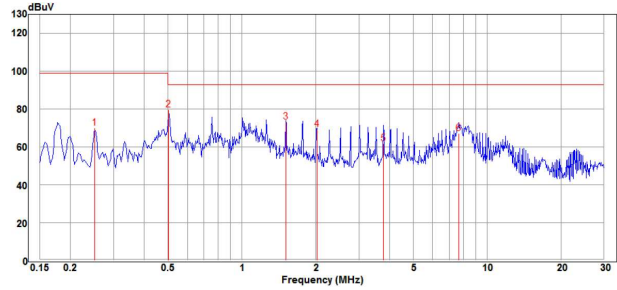

### EC7AW18-72D15-ECRT

Positive

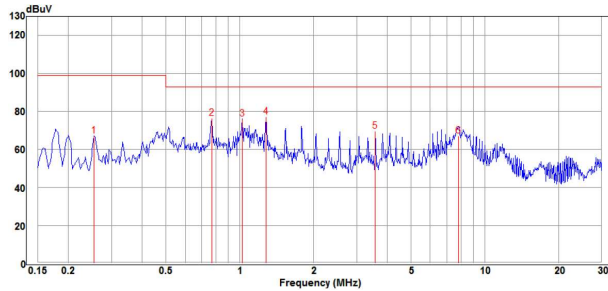

Negative

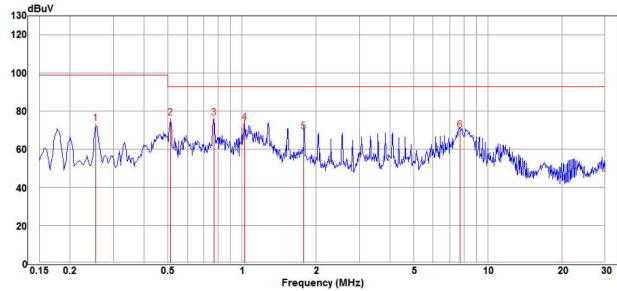

### Radiated Emission (EN55032):

#### EC7AW18-72S05-ECRT

Horizontal

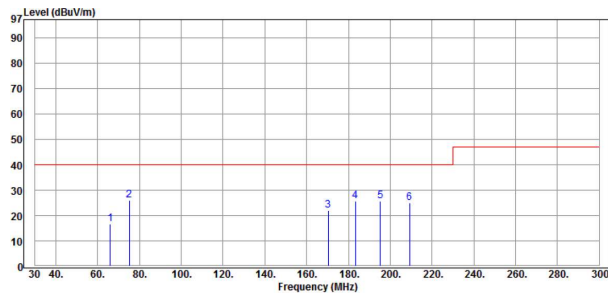

Vertical

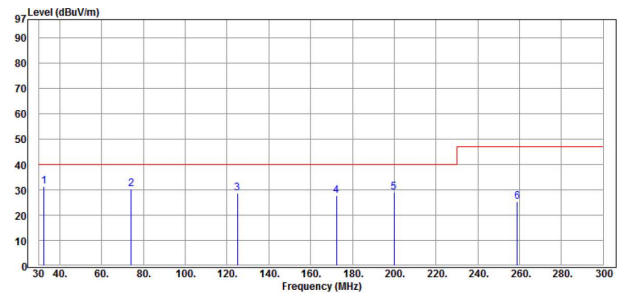

#### EC7AW18-72S12-ECRT

Horizontal

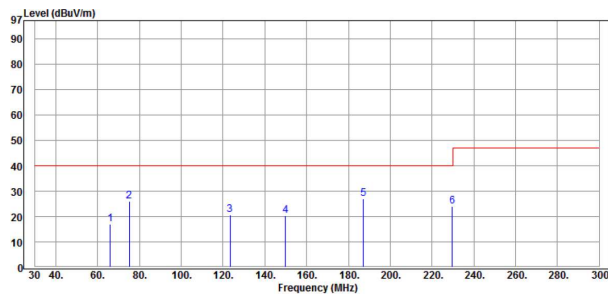

Vertical

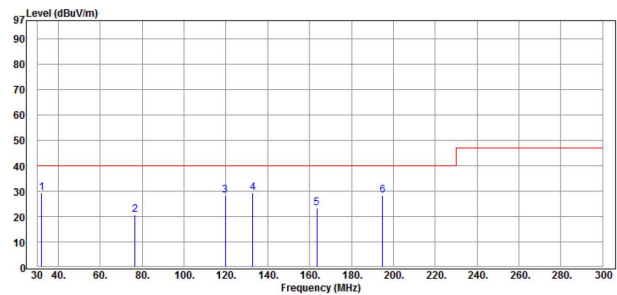



# EC7AW18 ECRT/EDRT Series

## Application Note V10

### EC7AW18-72S15-ECRT

Horizontal

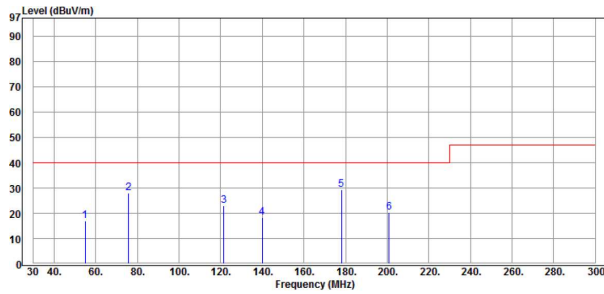

Vertical

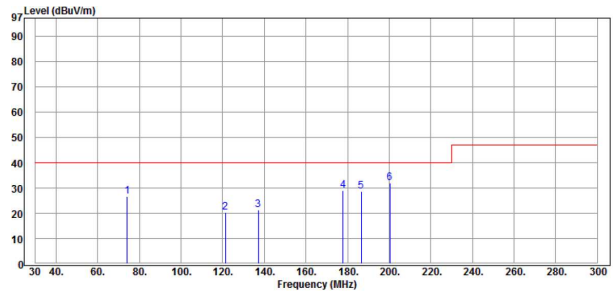

### EC7AW18-72D05-ECRT

Horizontal

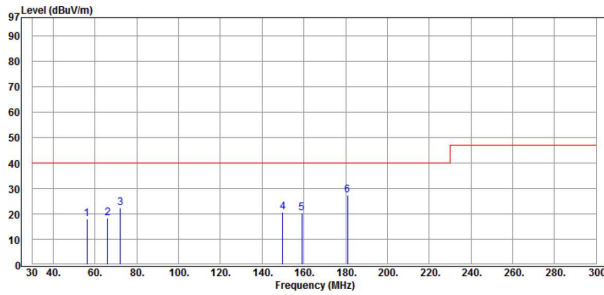

Vertical

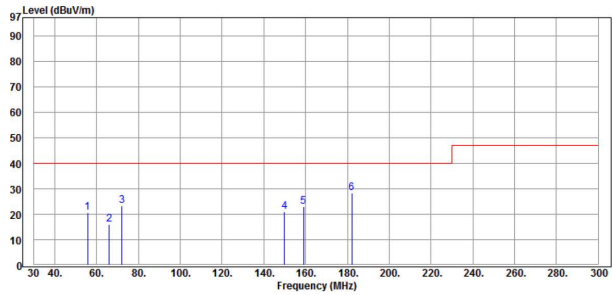

### EC7AW18-72D12-ECRT

Horizontal

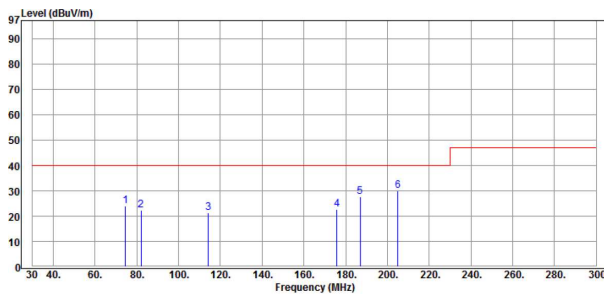

Vertical

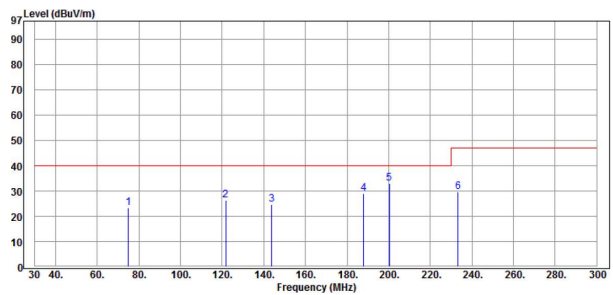

### EC7AW18-72D15-ECRT

Horizontal

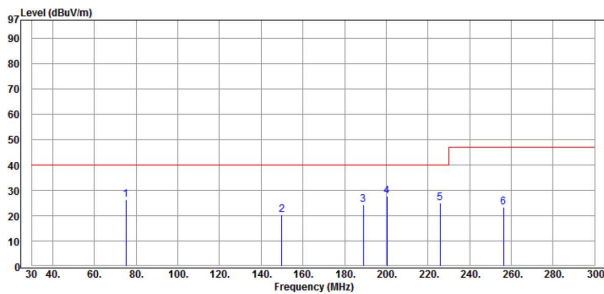

Vertical

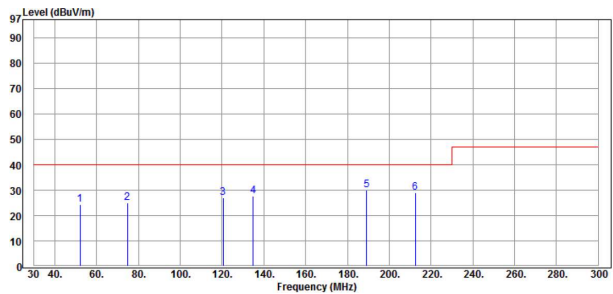





# EC7AW18 ECRT/EDRT Series

## Application Note V10

### Radiated Emission (EN50121-3-2):

EC7AW18-72S05-ECRT

Horizontal

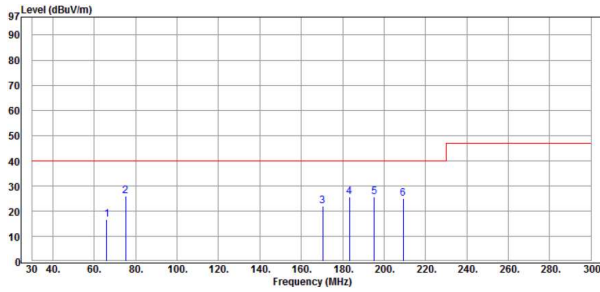

Vertical

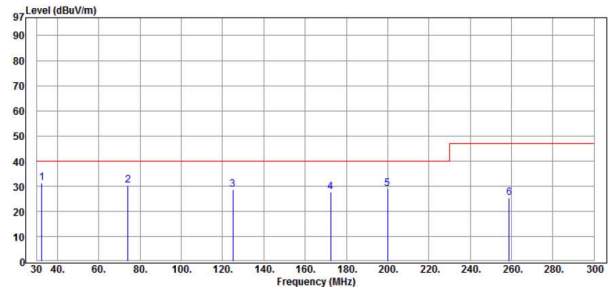

EC7AW18-72S12-ECRT

Horizontal

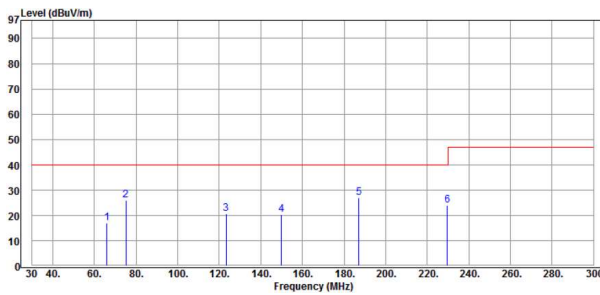

Vertical

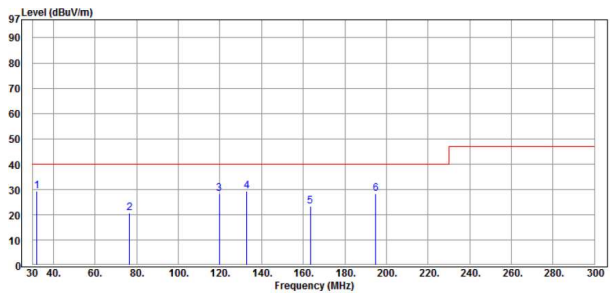

EC7AW18-72S15-ECRT

Horizontal

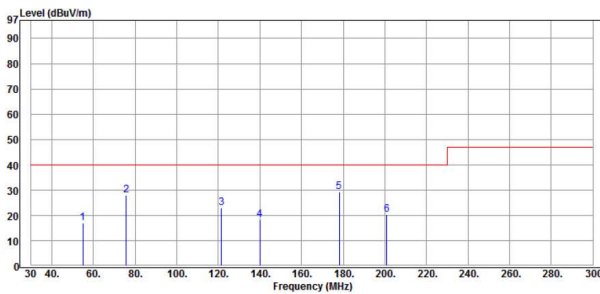

Vertical

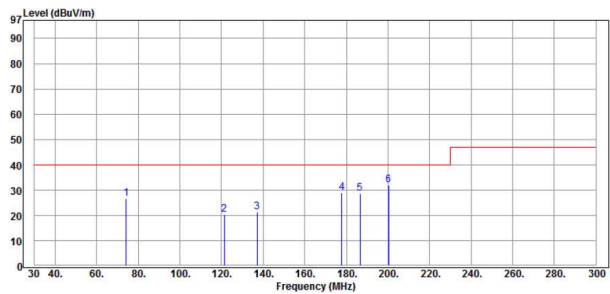

EC7AW18-72D05-ECRT

Horizontal

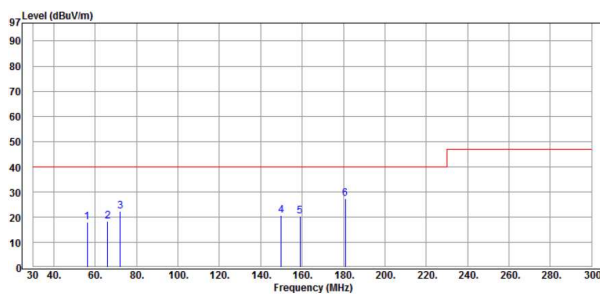

Vertical

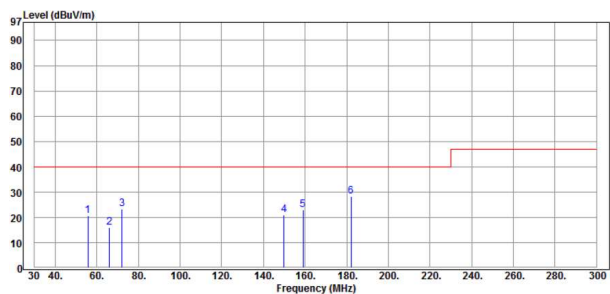



# EC7AW18 ECRT/EDRT Series Application Note V10

## EC7AW18-72D12-ECRT

Horizontal

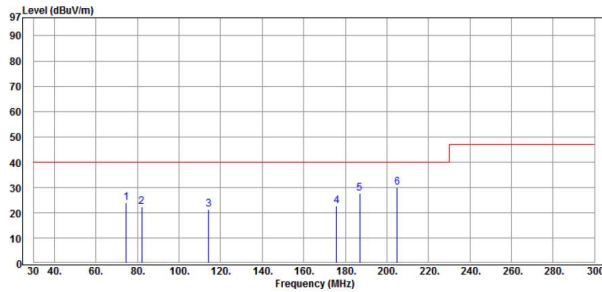

Vertical

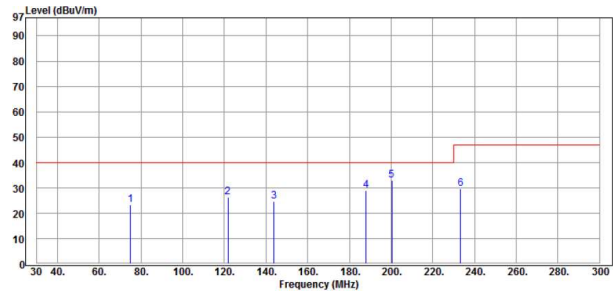

## EC7AW18-72D15-ECRT

Horizontal

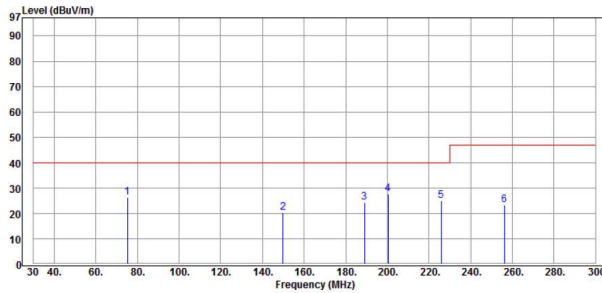

Vertical

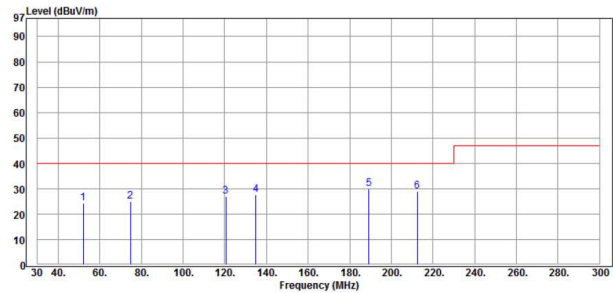

### CINCON ELECTRONICS CO., LTD.

#### Headquarters:

14F, No.306, Sec.4, Hsin Yi Rd.  
Taipei, Taiwan  
Tel: 886-2-27086210  
Fax: 886-2-27029852  
E-mail: [sales@cincon.com.tw](mailto:sales@cincon.com.tw)  
Web Site: <https://www.cincon.com>

#### Factory:

No. 8-1, Fu Kung Rd.  
Fu Hsing Industrial Park  
Fu Hsing Hsiang,  
ChangHua Hsien, Taiwan  
Tel: 886-4-7690261  
Fax: 886-4-7698031

#### Cincon North America:

1655Mesa Verde Ave. Ste 180  
Ventura, CA93003  
Tel: 805-639-3350  
Fax: 805-639-4101  
E-mail: [info@cincon.com](mailto:info@cincon.com)