

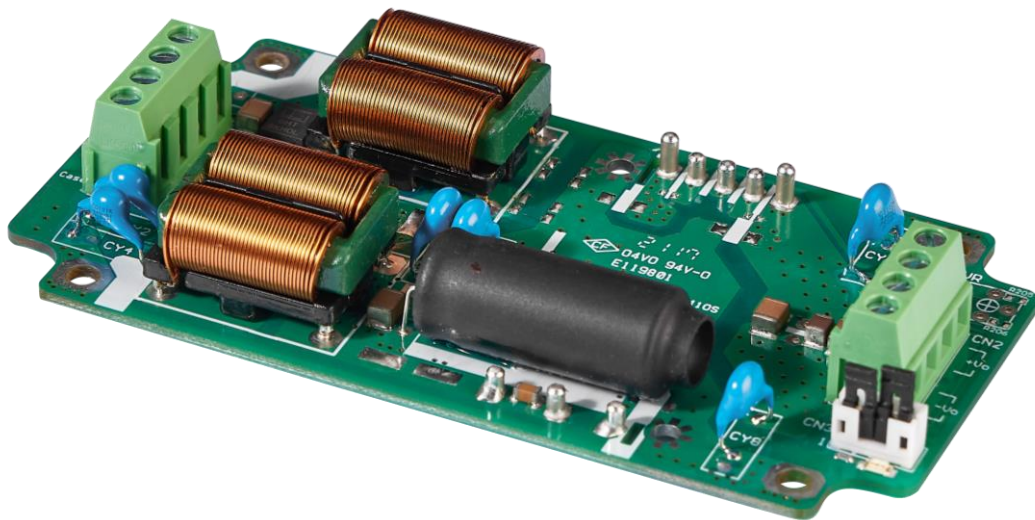

# EVB-CQB150(100)W-110S Series Application Note V10

## Evaluation Board for CQB150(100)W-110S Series APPLICATION NOTE



### Approved By:

Department	Approved By	Checked By	Written By
Research and Development Department	Jacky	Astray	Jiawei
Design Quality Department	Benny	JoJo	



# EVB-CQB150(100)W-110S Series Application Note V10

---

## Contents

1. Introduction .....	3
2. Pin Function Description Input and Output Connections.....	3
3. Output Remote Sense, Trim Resistors.....	4
3.1 Output Remote Sensing.....	4
3.2 Output Voltage Adjustment.....	4
4. Schematic .....	5
5. Component Placement.....	5
6. Bill of Materials (BOM) .....	7



# EVB-CQB150(100)W-110S Series Application Note V10

## 1. Introduction

The EVB-CQB150W-110S is the evaluation board for testing CQB150W(100W)-110S series. It has a wide (4:1) input voltage range of 43 to 160VDC. For help in testing the performance of DC-DC converters, please refer to the [CQB150W-110S application note](#), [CQB100W-110S application note](#).

### Shock Warning:

Certain areas of the evaluation board are exposed to high voltage. Be careful to avoid contact with these voltages. After disconnecting the input power, the evaluation board may temporarily maintain high voltage. Be careful when handling.

### Application of Input Power:

The evaluation board **prohibits hot plugging**, So **don't use** a knife switch or circuit breaker to connect the input power. This type of action applies the input voltage at an uncontrolled very high rate of rise (dV/dt), which may damage the converter and external components before the converter. The input voltage should be applied at a controlled rate of rise (recommend 10V/uS). Also, before inserting or removing the converter module from the evaluation board, make sure that the input voltage is turned off.

### Thermal Considerations:

When testing the converter on the evaluation board, ensure adequate cooling. Use a fan to blow the cooling air so that the fan blows through the converter or the radiator connected to the converter. The converter temperature to ensure that it does not exceed the maximum rated temperature specified in the data sheet.

### Sockets of DC DC Converter:

The evaluation board uses sockets to provide options for testing different converters. These sockets are not suitable for continuous high current. Short-term testing is possible, but please be aware of this limitation of long-term testing. The socket will add resistance in the power loop, which will cause a voltage drop at higher currents, which can cause significant errors in regulation and efficiency measurements. These socket also do not provide a thermal cooling path from the module pins to the PCB wiring, which may cause higher converter temperatures and errors when performing thermal evaluation. For long-term testing, thermal testing and permanent installation, it is recommended to use soldered connections.

## 2. Pin Function Description Input and Output Connections

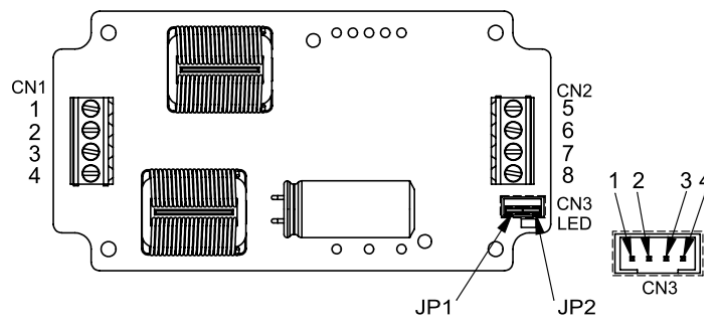

No	CN1&CN2	Description	No	CN3	Description
1	+V Input	Positive Supply Input	1	-V Output	Negative Power Output
2	-V Input	Negative Supply Input	2	-Sense	Negative Output Remote Sense
3	Remote	External Remote On/Off Control	3	+Sense	Positive Output Remote Sense
4	Case	Connected to DC Module Case	4	+V Output	Positive Power Output
5	+V Output	Positive Power Output			
6	+V Output	Positive Power Output			
7	-V Output	Negative Power Output			
8	-V Output	Negative Power Output			

Note: DC module Case can be connected to PCB through M3 threaded mounting insert. Recommended torque 3Kgf-cm.



# EVB-CQB150(100)W-110S Series

## Application Note V10

### 3. Output Remote Sense, Trim Resistors

#### 3.1 Output Remote Sensing

The CQB150(100)W-110S series converter has the capability to remotely sense both lines of its output. This feature moves the effective output voltage regulation point from the output of the unit to the point of connection of the remote sense pins. This feature automatically adjusts the real output voltage of the EVB-CQB150(100)W-110S series in order to compensate for voltage drops in distribution and maintain a regulated voltage at the point of load. The remote-sense voltage range please refer to the [CQB150W-110S application note](#), [CQB100W-110S application note](#)

When remote sensing is used, please remove the jumper of CN3 and the sense should be connected by twisted-pair wire or shield wire. If the sensing patterns short, heavy current flows and the pattern may be damaged. Output voltage might become unstable because of impedance of wiring and load condition when length of wire is exceeding 400mm. This is shown in the schematic below.

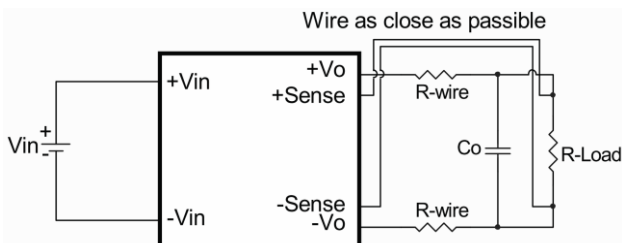

When the EVB-CQB150(100)W-110S was shipped from a factory, they come with JP1 and JP2 placed on CN3. If the remote sense feature is not to be used, the sense JP1 and JP2 should be connected locally.

#### Note:

Although the output voltage can be varied (increased or decreased) by both remote sense and trim, the maximum variation for the output voltage is the larger of the two values not the sum of the values. The output power delivered by the module is defined as the voltage at the output terminals multiplied by the output current. Using remote sense and trim can cause the output voltage to increase and consequently increase the power output of the module if output current remains unchanged. Always ensure that the output power of the module remains at or below the maximum rated power. Also be aware that if  $V_{o.set}$  is below nominal value,  $P_{out.max}$  will also decrease accordingly because  $I_{o.max}$  is an absolute limit. Thus,  $P_{out.max} = V_{o.set} \times I_{o.max}$  is also an absolute limit.

#### 3.2 Output Voltage Adjustment

EVB-CQB150(100)W-110S is shipped without trim resistor for output voltage adjustment, output voltage can be adjusted by external variable resistor (adjustment range: please refer to the [CQB150W-110S application note](#), [CQB100W-110S application note](#)).

#### Note: Description of Trim Resistors

Fixed resistor R204 and R206 are used to adjust down the output voltage set-point of the converter.

Fixed resistor R203 and R205 are used to adjust up the output voltage set-point of the converter.

The trim resistors R203, R204, R205, R206 and VR are not populated in this evaluation board. This is to allow the user to determine and install the needed trim resistance values based on the range of desired output voltage adjustment of the module being evaluated.



# EVB-CQB150(100)W-110S Series Application Note V10

## 4. Schematic

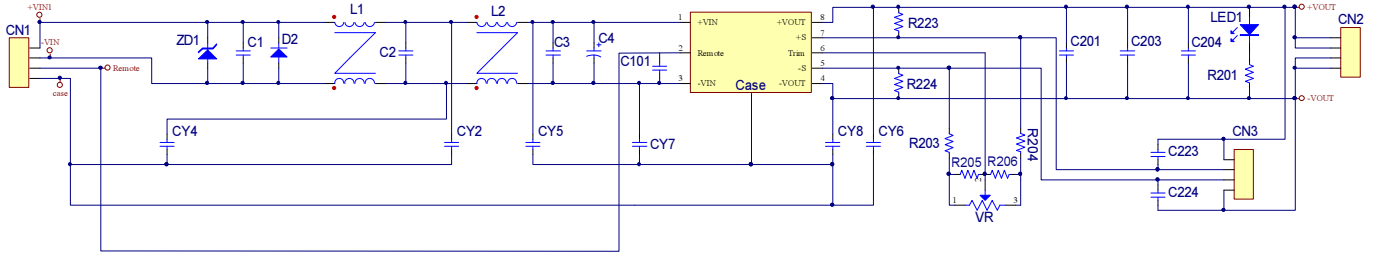

Figure1 Schemati

## 5. Component Placement

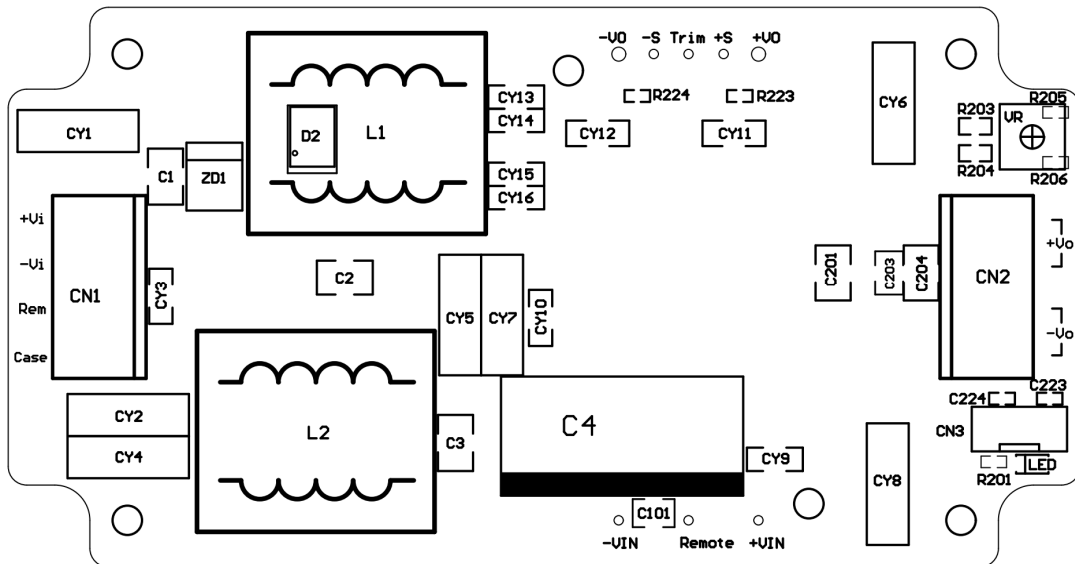

Figure2 Component Placement

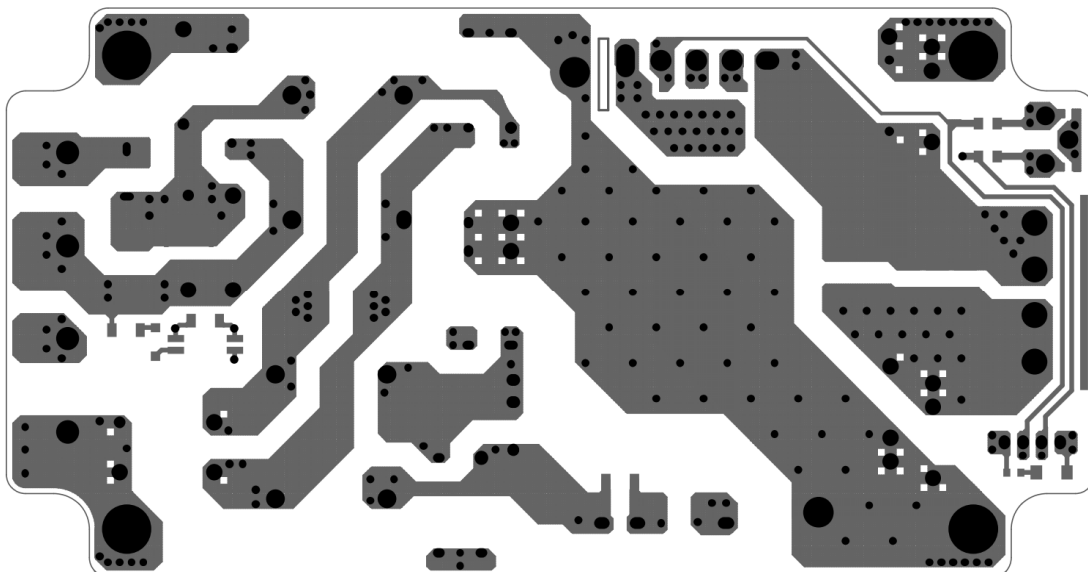

Figure3 PCB Layout Top View



# EVB-CQB150(100)W-110S Series Application Note V10

---

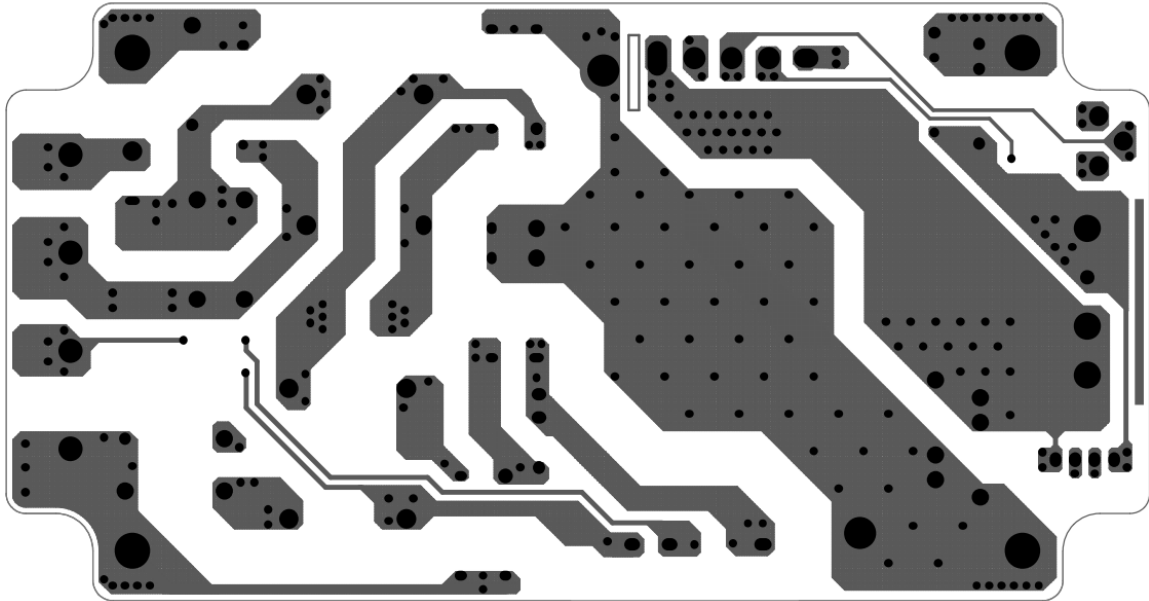

Figure4 PCB Layout Bottom View



## EVB-CQB150(100)W-110S Series Application Note V10

### 6. Bill of Materials (BOM)

Components value:

Designator	Description	Value	Comment
C4	ALUMINUM CAP.	120uF/220V	EKXJ221ELL121MK30S or equivalent
CY2, CY4	Y1 CAP.	100pF/400VAC	CD70-B2GA101KYNKA or equivalent
CY5, CY6, CY7, CY8	Y2 CAP.	2200pF/300V	CS80ZU2GA222MYNKA or equivalent
L1, L2	Common choke DIP	5mH	CINCON Part Number G91CA225822
Using in CN3	MINI JUMPER	2.0mm Pitch	HMJ20-02O-95BS or equivalent
CN1, CN2	TERMINAL BLOCK	300V 20A	EK500V-04P or equivalent
CN3	WAFER DIP	2.0mm Pitch	P110I-04 or equivalent
R201	CHIP RESISTOR	1/10W 100K	SMD 0603
C1, C2, C3	CHIP CAP.	1uF/250V X7R	SMD 1812
C101	CHIP CAP.	0.1uF/250V X7R	SMD 1206
C201, C204	CHIP CAP.	4.7uF/100V X7R	SMD 1812
C203	CHIP CAP.	2.2uF/100V X7R	SMD 1210
D2	ULTRAFAST DIODE	300V 8A	STTH8R03DJF-TR or equivalent
LED1	LED	Green	MS-PT3216ZGSC or equivalent
ZD1	TVS	1500W 211.5V 5%	SMCJ180A or equivalent
P1, P2, P3, P5, P6, P7	SOCKET	1mm	1726TLG or equivalent
P4, P8	SOCKET	1.5mm	3819TLG or equivalent

#### Headquarters:

14F, No.306, Sec.4, Hsin Yi Rd.  
Taipei, Taiwan  
Tel: 886-2-27086210  
Fax: 886-2-27029852  
E-mail: [support@cincon.com.tw](mailto:support@cincon.com.tw)  
Web Site: <http://www.cincon.com>

#### CINCON ELECTRONICS CO., LTD.

#### Factory:

No. 8-1, Fu Kung Rd.  
Fu Hsing Industrial Park  
Fu Hsing Hsiang,  
ChangHua Hsien, Taiwan  
Tel: 886-4-7690261  
Fax: 886-4-7698031

#### Cincon North America:

1655Mesa Verde Ave. Ste 180  
Ventura, CA93003  
Tel: 805-639-3350  
Fax: 805-639-4101  
E-mail: [info@cincon.com](mailto:info@cincon.com)